

BALAZS

36



WEXFORD

GEORGE BALAZS

Wide Ruled 808-683-8402

Composition Book

PNPA III 11-18 APRIL 24

14-24 JUNE 24

DIVER 21

#26-53

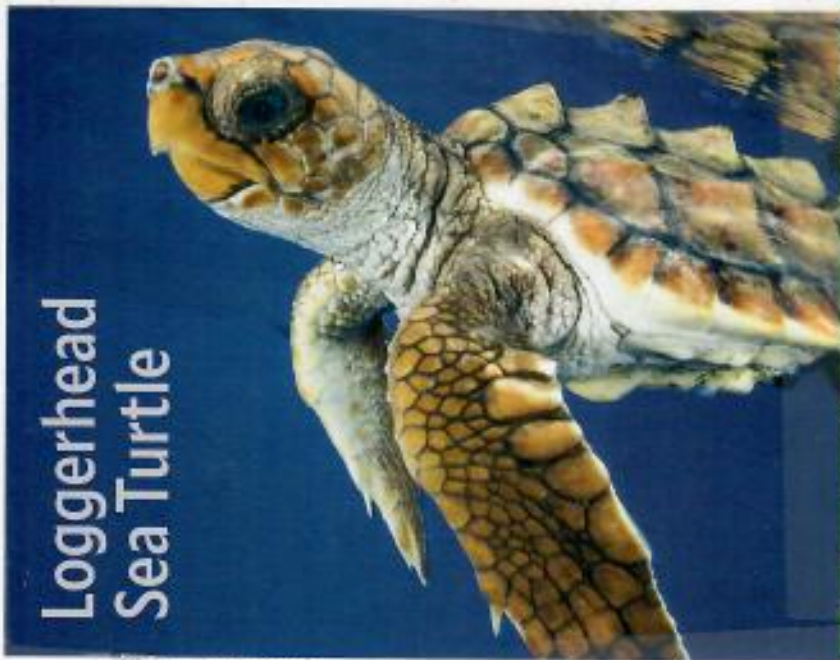

Loggerhead
Sea Turtle

37 x 66

STRETCH

WHY THINGS HAPPEN

ARIGATO GOZAIMASU

CLASS SCHEDULE

DATE _____

NAME _____ SCHOOL _____

ADDRESS 14-24 JUNE 2024 N=28+
1 MOCK

PERIOD	MONDAY LUNDI LUNES	RM.	TUESDAY MARDI MARTES	RM.	WEDNESDAY MERCREDI MIÉRCOLES	RM.	THURSDAY JEUDI JUEVES	RM.	FRIDAY VENDREDI VIERNES	RM.
1	ARGOS - 401.678 MHz FREQUENCY									
2	OUTPUT - 200 MILLIWATTS									
3	2024 SAT PHONE - 00-8816-234-52310 <i>from cell</i>									
4	FROM LANDLINE 011-8816-234-52310									



04

Chapter I

Lake Biwa, the Origin of Shiga Life and Culture

滋賀の文化の源泉

amazon.com



SQ75T8FDZQ

Order #: 63467374
 Order date: May 31, 2024 (Order ID 113-6917742-4950658)

Item	Item Price	Total
Digital Thermometer for Adults and Kids, No Touch Forehead Thermometer for Baby, 2 in 1 Body Surface Mode Infrared Therm... 002NFD1LJ HTD8813C-KJ01-M8-912 193674503271 (Sold by hataida)	\$17.99	\$35.98
(120 Pcs - Bulk Value) Ref. 8 oz Paint Mixing Cup/Racin Mixing Cups Disposable Measuring Cups Clear Plastic Mixing ... Kitchen B09TX1VN11 RL-PMC08-120 606301081207 (Sold by Ref.)	\$17.49	\$17.49
Supmedic Nitrile Exam Glove, 3.5 mil Disposable Medical Gloves \$7.98 Powder-Free Latex-Free, Box of 100 pcs (Blue) (X-Large) Apparel B0C9SHW1VK SNF-BLUE-XL-100 850049592444 (Sold by Supmedic)	\$7.98	\$25.94
Pro Grade Chip Paint Brushes - 96-Pack - 1" Chip Brushes for Stains, Varnishes, Glues, & Gesso - Home Improvement...	\$28.99	\$28.99

Ship to: 609311410319 (Ship by Prime)
 Total: \$100.00

11/18/2022 Mock SCL 30.3 cm

6/21/2023 HAVOLI SCL 35.8 cm
 = 5.5 cm

0.79 cm / mo = 9.48 cm / YEAR
 7 MONTHS

July 10 COHORT 1 2023 Release
N=25 4pm HST 39°18.9N Latitude



146°04' W Longitude

04-13-2024

24.8 C Seawater

Lφ

SHIKOKU AQUARIUM

MOI

GALAXY ACE

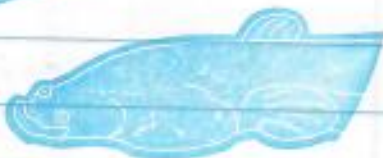

Kyoto University
HIDEAKI NISHIZAWA

TOMIYAMA



"FIRMAMENT ACE"

SPLASH 10 = 119 grams

Lφ 387 SPOT 6 = 39 grams

4-14-2024



TOMIYAMA

MEITETSU ENIN

SUNDAY

STAYS AT KANEYAMA



2024- FIRMAMENT ACE (4)
 IMO 9293894
 CAPT. DANILLO S. SABUCIDO JR.

領収書
 ご利用日付 2024年06月20日
 時刻 17時24分
 取引内容 乗車券 金 400円
 伝票番号 50426
 消費税率10% (税込)
 金山駅 券101発行
 JR東海
 登録番号 T3180001031569

CASADERA



OMI-HACHIMAN

24.-6.23 00033
 駿府城公園 共通券

大人 360円

- ※本券は、発効日のみ有効です。
- ※施設受付で本券をご提示ください。
- ※本券1枚で大人1人入場できます。
- ※払い戻しはできません。
- ※本券をもって領収書といたします。

1. 東御門・翼櫓

受付
 6.23
 東御門

入場印

2. 紅葉山庭園

受付
 6.23
 紅葉山

入場印

3. 坤櫓

受付
 駿府城公園へ
 6.23
 坤櫓

入場印

発券所 駿府公園 東御門



2023 COHORT #1

PPT#	NAME	DAYS TRANSMITTING	TOTAL DISTANCE COVERED	SPEED (km/h)	
243178	Satsuki	262	7559	1.20	
143179	Ka La Ula	259	6127	0.99	
243180	Kumeyaay	262	6783	1.08	
243181	Antonio	246	5891	1.00	
243182	Sumire	229	5517	1.00	
243183	Azami	238	6512	1.14	
243184	Kal Maleno	232	5670	1.02	
243185	Luiseno	230	6375	1.15	
243186	Bety	229	6156	1.12	
243187	Nadesiko	243	6284	1.08	
243188	Pua Sakura	245	6455	1.10	
243189	Akamai	229	7396	1.35	
243190	Juaneno	228	6616	1.21	
243191	victor	247	6948	1.17	
243192	Sazanka	258	8439	1.36	
243193	Ajisai	257	6202	1.01	
143195	Gabrioleno-Tongva	245	6553	1.11	
243196	Marisel	233	5280	0.94	
243197	Tsubaki	248	7883	1.32	
243199	Lali	197	5240	1.11	
243200	Chumash	250	6312	1.05	
243201	Chuy	233	6021	1.08	
243202	Asagao	240	5753	1.00	
		241	6434	1.11	Red = Mean Values
243198	Ayame	30	551	0.77	Transmissions ended prematurely
243194	Hauoli	67	1182	0.74	Transmissions ended prematurely

Nagoya City
Koyo Senior High School

Science & English teacher

SABINA STUDENT'S FATHER
KENT WINTEROWD



47 Hiroike-cho, Showa-ku, Nagoya, Aichi 466-0042, JAPAN
TEL: +81-52-841-7138 FAX: +81-52-853-2543
e-mail: kgsski@nagoya-c.ed.jp
URL: http://www.koyo-h.nagoya-c.ed.jp/

9/20/24

over

名古屋港ポートビル



24. - 6. 21 No. 2A-19653

単 独 券
大人 300円 (1人1回)

①・②・③のうち、
1つの施設に入場できます。

- ①南極観測船
- ②海洋博物館 (ポートビル3階)
- ③展望室 (ポートビル7階)

13:54

BALAZS/GEORGE
6Z84G4 2 PC
PRINT DATE GMT: 14JUN24
HNL
0 173 HA 307120 **136**

OSAKA KANSAI INTL

KIX

HA449 14JUN 14:35



0 173 HA 307120

EAT / SHOP / PLAY: O'AHU

Use promo code
HANAHOU for
\$65 per person
all ages special!



ULTIMATE CIRCLE ISLAND TOURS

Waikiki, Hawaii

Ultimate Circle Island Tours prides itself in providing custom client relationships through our 16-Location boutique family-style tours. We are one of only a few Oahu circle island tours that include the chance to swim with the noble Hawaiian green sea turtles on Oahu's North Shore. Come with us to enjoy a full day of exploring Oahu.



(808) 460-6163

ultimatercircleislandtours.com



6/15
2024

6

FR. DAY 14-24 MONDAY JUNE 2024

BALAZS/GEORGE
6Z84G4 2 PC
OSAKA KANSAI INTL
KIX HA449 14JUN 14:35

BALAZS/GEORGE
6Z84G4 2 PC
OSAKA KANSAI INTL
KIX HA449 14JUN 14:35

PRINT DATE GMT: 14JUN24



0 173 HA 307121

PRINT DATE GMT: 14JUN2



0 173 HA 307120

GB, ME & JACK →

6/15 SAT. 635pm ARRIVE KIX
SAT. CHECK IN NIKKO HOTEL
6/16 SUNDAY TO NAGOYA by TRAIN

JAPAN RAIL PASS (ORDINARY 7DAYS) 567 -41

2024-6.21~2024-6.27 (普通車 7日乗用)

2024-6.21 YEAR-MONTH-DAY (普通車 7日乗用)

This pass is non negotiable. Insert it in ticket gates and don't forget to take it.

¥50000(A) (3-夕) 10519-01 C24

70974-422

7345/1733-470377 2024-6.21名古屋MR18発行

9023 NOTES ABOUT COHORT #1 RELEASE -
- SUMIRE & #10 NADASIKO DID NOT FEED AT ALL ON GALAXY ACE,
- #6 AZAMI & #19 MARISAL HARDY ATE ANYTHING ON GALAXY ACE

8



【クレジット売上票】
CREDIT CARD SALES SLIP

加盟店名 MERCHANT 247997-17 247 174

電話番号 0749-62-3851
IC/HS識別子 IC VISA CREDIT
A I D A0000000031010
カード会社 SMCC(2a99663)
端末識別番号 50129-211-10498
ご利用日 DATE 24/06/22 12:09:04
会員番号 ACCT.# 438857XXXXX4036
氏名 BALAZS/GEORGE
カード番号 03 A T C 00b5
有効期限 XX年XX月 伝票番号 01333
処理番号 0000939 取扱区分 110
取引内容 売上 商品区分 990
支払区分 一括(10)
承認番号 APP.CODE 0071474
取引番号 0077574333-000
合計金額 ￥4,600

お知らせ
ご利用ありがとうございました。

売場: TAX 係員: お客様控え

FamilyMart

名古屋港店
愛知県名古屋市港区入船 2-3-3
電話: 052-659-1331
登録番号: T1180002054158
2024年 6月20日 (木) 8:33
レシ 3-7847 費No. 005

領 収 証

いいちこ 20° 瓶 麦 ￥943
合 計 ￥943
(10%対象 ￥943)
(内消費税等 ￥85)
クレジット支払 ￥943

クレジット支払

取引日 2024年 6月20日
伝票番号 CL 33510
会員番号 **** * 4036
会社名 VISA
承認番号 00157D
支払区分 一括
支払金額 ￥943
A I D A0000000031010

お客様控え

You replied on Mon 7/8/2024 2:56 AM

7

The 2nd cohort's deployment has taken place perfectly as below! N=28

The release point: 39°33.4669' N 148°29.7291' W

Sea surface temperature: 18°C

Started time: 14:10 (UTC -11)

Finished time: 14:45

We will send the photos later.

Best regards
Noah&Cat

世界各地にある6,000以上のホテルとリゾートで、会員限定の特典を楽しみ、ポイントを獲得しましょう。

今すぐ入会して、特典をご利用ください
IHG.COM/ENROLJP

Enjoy exclusive benefits and earn points at over 6,000 hotels and resorts worldwide.

JOIN NOW FOR INSTANT BENEFITS
IHG.COM/ENROLNOW

客室/Room:

grandcourt

Wi-Fi/Wi-Fi

17A2J
2001
2007 1805M

~ 6/26



矢場町本店
 米田セレクトライズ店
 米田松坂屋店
 ショッピングセンター
 名古屋駅前名鉄店
 名古屋駅エスカレーター
 名古屋丸一センター店
 ヌメーブルジャフ-△店
 中部国際空港海店
 東京銀座店



6/19/24

名古屋名物 矢場町 名古屋駅 名古屋市内



名古屋名物 矢場町

6/19/24

環境に配慮し、箸をリユースしています。

JTB	EXCHANGE ORDER NOT GOOD FOR PASSAGE PASSENGER COUPON お客様用片引換証		ISSUED BY 発行者 JTB Corp.		 00324001313 <small>THIS ORDER IS NOT VALID AND WILL NOT BE HONORED UNLESS PURCHASED FROM ITS OR AUTHORIZED TRAVEL AGENT.</small>
	NAME OF PASSENGER 氏名 NOT TRANSFERABLE 譲渡禁止 Balazs George Harvey				
TYPE OF SERVICE FOR WHICH ISSUED バスの種類 JAPAN RAIL PASS ORDINARY / 7DAY(5) / ADULT		DATE OF ISSUE 発行月日 03-JUN-2024		<div style="border: 1px solid black; padding: 5px; text-align: center;"> JTB USA, INC. HONOLULU 03-JUN-2024 PLACE OF ISSUE 発行箇所 </div>	
<EXCHANGE> Must be exchanged for pass within 3 months of the date of issue. Exchange is only available when the exchange office is open. Please check the exchange office hour in advance.		EXCHANGED BY 引換期限 02-SEP-2024			
VALUE FOR EXCHANGE	AMOUNT IN LETTERS 日本円発行額 FIFTY THOUSAND	CURRENCY JPY	AMOUNT IN FIGURES 50,000		RATE OF EXCHANGE 交換率 1USD=148.8300JPY
	EQUIVALENT AMOUNT PAID IN FIGURES 現地通貨換算 THREE HUNDRED THIRTY SIX POINT ZERO ZERO	USD	336.00		
TO JAPAN RAILWAYS GROUP		IN JAPAN		ENDORSEMENTS JRP1-C-00183663	
RESERVATION DATA 予約事項					
REMARKS 備考 <VALIDITY> Tourist who enter Japan with passport issued by a country other than Japan : Admitted under entry status "TEMPORARY VISITOR".					

APRIL 2024

Notes - 4-13-2024 Saturday
TO UTAZU, SHIKOKU

Notes

10

4th
HPU

Carrying Capacity - ALL other Papers, ie Japan
Ryukyu - KAMEZAKI

KAREN BJORNDAAL / MIKAWI / ASUKA / IK

SHORELINE
Fishing - entanglement issue

IDENTIFICATION CARD

ご宿泊確認書

6/16/24

Room No.
お部屋番号

4037

Room Rate
お部屋料金

ご芳名
Name

MR. GEORGE BALAZS

No. of Guest(s)
ご利用人数

1

Arrival Date
ご到着日

2024/06/15

Departure Date
ご出発日

2024/06/16

Deposit
お預かり金

現金 Cash
 クーポン Coupon

6/17
6-24 June 2024

DAY 1 MONDAY 6/17/24
N=7 / ALL SPOT 6 387

DAY 2 TUES. 6/18
N=7 (6 SPOT 6 387
1 SPLASH 10
#40)

DAY 3 Wed. 6/19
N=7 5 SPOT 6 387
and 2 SPLASH 10
#42 & #44

DAY 4 THURS. 6/20
N=6 + 1 Dummy
ALL SPOT 6 387

TOTAL - 28
+ 1 Mock
SPOT 6 387
(PUPA Display)

9107 4000 1000
国宝

三十三間堂

17

A 734511

SANJUSANGENDŌ



600円

6/22/24
Kyoto

+

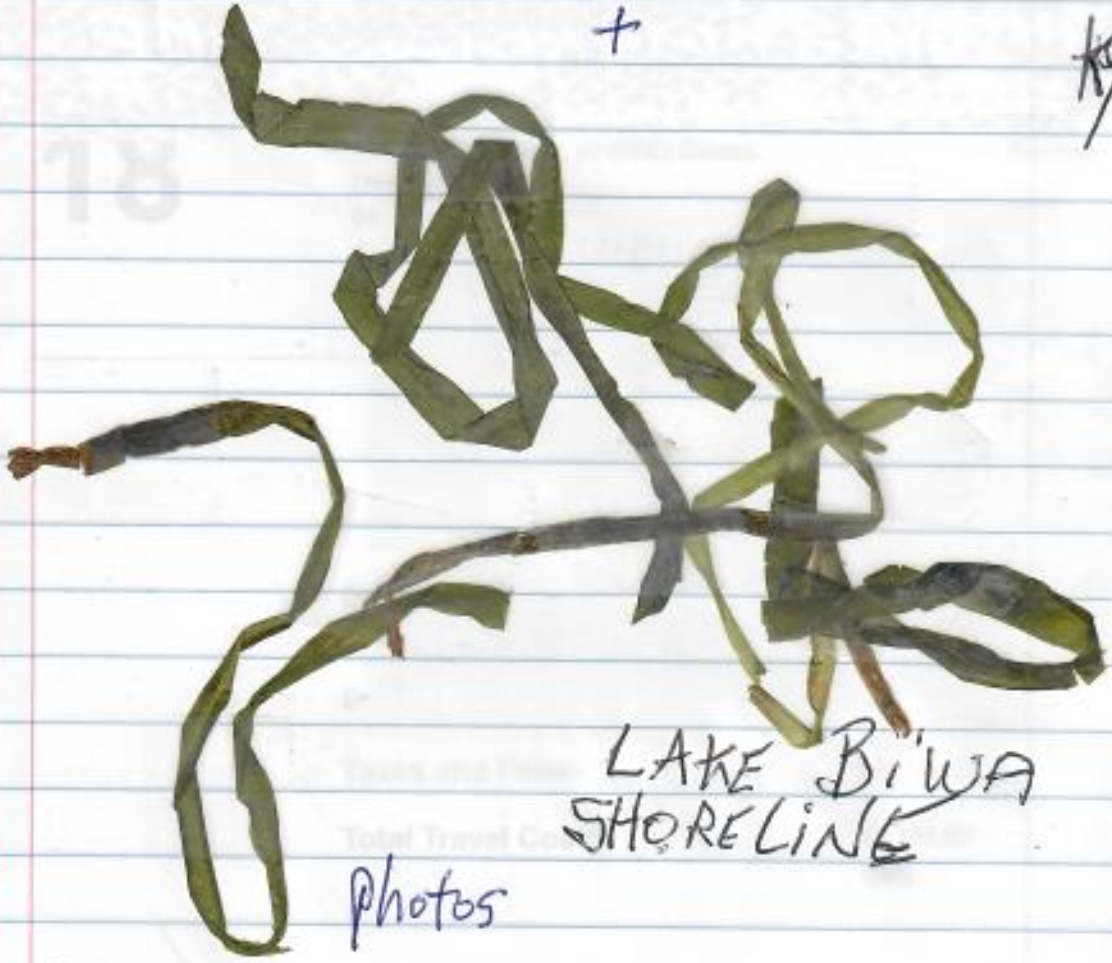

LAKE BIWA
SHORELINE

photos

Amount charged: 27182.00 USD to the Master Card ending in 2497 of George Sutter
Major Status
Cardholder's number: 11219070
Expires: 07/2010-07/2011

APRIL 2024 TRIP

HAWAIIAN AIRLINES TSA PRECHK BOARDING PASS



BALAZS/GEORGE HARV

M

FLIGHT HA450 C 18APR2024 KIX > HNL

GATE	BOARDING STARTS	ZONE	SEAT
30	07:55PM	1	1H
BOARDING ENDS 08:30PM			

LOYALTY: HA****970 Pualani Platinum
CONFIRMATION CODE: 6HGSQU
E-TICKET: 1732305496211
SEQ: 0164 (V110208)
SAKURA LOUNGE



NAME
BALAZS/GEORGE HARV

FLIGHT FROM TO
HA450 OSAKA/KIX
C HONOLULU/HNL

DEPART ARRIVE
08:45PM
09:20AM

ZONE SEAT
1 1H
*TOW/UPG

PRIORITY

知はびわ湖を見に行き
たい。近くびわ湖を水
子で泳ぐのはいい。
お土産に毛織物。
MAIBARA TAXI
TO LAKE BIWA 6/24/24

Apr
11

HNL → KIX

Guest

Details

14

Flight HA 449
Oahu - Honolulu, HI (HNL) to
Osaka Kansai, Japan (KIX)
Depart
04/11/2024 02:00 PM
Arrive
04/12/2024 06:45 PM

Seat 02G
Business

Apr

KIX → HNL

Guest

Details

Flight HA 450

18

Osaka Kansai, Japan (KIX) George
to Oahu - Honolulu, HI (HNL) Balazs
Depart
04/18/2024 08:45 PM
Arrive
04/18/2024 09:20 AM

Seat 01H
Business

Payment Summary

Base Airfare:	\$2,711.00 USD
Seat Cost:	-
Taxes and Fees:	\$481.60 USD
Total Travel Cost:	\$3,192.60 USD

Amount charged: \$3192.60 USD to the Master Card ending in 8440 of George Balazs

George Balazs
HawaiianMiles member: 115219970
eTicket#: 173-2305496211

0 173 HA 059079

APRIL 2024



HA449 11APR 14:00

KIX

KANSAI INTL

HAWAIIAN AIRLINES TSA PRECHK

BOARDING PASS

BALAZS/GEORGE HARV

FLIGHT HA449 C 11APR2024 HNL > KIX

GATE	BOARDING STARTS	ZONE	SEAT
C2	01:15PM	1	2G
	BOARDING ENDS 01:45PM		

PRIORITY

LOYALTY: HA****970 Pualani Platinur
CONFIRMATION CODE: 6HGSQU
TICKET 12305498211
0178

PLUMERIA LOUNGE

BALAZS/GEORGE
6HGSQU1 PC
PRINT DATE GMT: 11APR24
HNL
0 173 HA 059079

143



NWE
BALAZS/GEORGE HARV

FLIGHT FROM TO	HA449 HONOLULU/HNL OSAKA/KIX	C
DEPART ARRIVE	02:00PM 06:45PM	
ZONE	1	SEAT 2G
STBY/UPG		

PRIORITY

BALAZS/GEORGE
6HGSQU 1 PC
OSAKA KANSAI INTL
KIX HA449 11APR 14:00

PRINT DATE GMT: 11APR24



0 173 HA 059079

NAGOYA
 depart 4-11-24 TO 4-18-24
 2 PM Thursday

16

ARRIVE KIX 4-12 Friday ~ 6:50 PM - 1 hour customs IMMIG.

00324000523
 THIS ORDER IS NOT VALID AND WILL NOT BE HONORED UNLESS PURCHASED FROM JTB OR ITS AUTHORIZED TRAVEL AGENT.
 JTB USA, INC.
 HONOLULU
 05-MAR-2024
 PLACE OF ISSUE 発行箇所
 RATE OF EXCHANGE 交換率
1USD=140.1600JPY
 ENDORSEMENTS
 JRP1-C-00182694

Room No. 7046 Room Rate
 お部屋番号 お部屋料金
 氏名 MR. GEORGE BALAZS
 No. of Guest(s) 1
 ご利用人数
 Arrival Date 2024/04/12 Departure Date 2024/04/13
 ご到着日 ご出発日
 Deposit お預かり金
 現金 Cash
 クーポン Coupon

【クレジット売上票】 G
 加盟店名 HOTEL NIKKO KIX 51
 072-455-1111
 端末番号 40712-560-60550
 ご利用日 24/04/12 9:55:39
 伝票番号 21862
 会員番号 XXXXXXXXXXXX4036(TC)
 承認番号 062014
 取引内容 売上
 カト*会社
 ヒ*サ/マサ
 支払区分 一括
 有効期限 XX/XX
 取扱区分 110
 金額 ¥16,560
 合計金額 **¥16,560**
 BALAZS GEORGE
 ご利用ありがとうございました
 またのご来店お待ちしております
 A0000000031010
 S374064 C03 A00123 VISA
 売場: 係員:
 00
 e590928d69c0ade3
 INFOX
 お客様控え 4/12/24



AYODAN

指定券
RESERVED SEAT TICKET
関西空港 → 新大阪
KANSAI AIRPORT → SHIN-OSAKA
APR. 13 (8:08発) (9:06着) C11
HARUKA 6 CAR. 2 SEAT. 6-B

2024-4.12関西空港F12(4-) 50089-01
7345/1034-219758

AT-Company 11
クレジット売上票 Card Party
加盟店名 トリツエツカ & DYNAMIS
MERCHANT 06-6885-0512
端末番号 7111-520-42185
ご利用日 DATE 2024/04/13 09:06:24
会員番号 498857*****4016 IC
ACCT #
カード会社 CARD COMPANY ビザ VISA
承認番号 APP CODE 008740D
処理通番 TRAN No 0098840
取引内容 伝票番号 有効期限
売上 30118 XX/XX
支払区分 取扱区分 商品区分
一括 110 310
金額 ¥880
AMOUNT CARDHOLDER/VISA 様
ご利用ありがとうございました
またのご来店をお待ちしております
ARC 00 ATC 00124 No.03
AID A0000000031010
VISA
APP LABEL VISA CREDIT
売場 SALES 係員 CLERK
GMO-F&G お客様控え
登録番号 03

新幹線指定券
RESERVED SEAT TICKET
新大阪 → 岡山
SHIN-OSAKA → OKAYAMA
APR. 13 (9:20発) (10:10着) C02
SAKURA 549 CAR. 8 SEAT. 3-A

2024-4.12関西空港F12(4-) 60090-01
7345/1034-219758

指定券
RESERVED SEAT TICKET
岡山 → 宇多津
OKAYAMA → UTAZU
APR. 13 (10:35発) (11:07着) C02
SHIOKAZE 7 CAR. 1 SEAT. 7-A

F12(4-タ) 00091-01

Dinner
4-13-24 様
KANAYAMA 額収証
¥2,618-
初クレジット ¥2,618
(消費税等 238円を含みます)
但し、飲食代として
名古屋市中区金山1丁目17-1 アスナル金山内
とんかつ マ・メゾン アスナル金山店
tel 052-332-270

* 財布等で保管載く場合、印紙面を内側に折って保管願います

(18)

4-13-2024
Saturday

UTAZL, shikoku AQUARIUM



Wildlife Computers
8310 154th Avenue NE, Suite #150
Redmond, WA 98052
USA
Voice: +1 425.881.3048
Fax: +1 425.881.3405
Email: tags@wildlifecomputers.com

Invoice

Invoice Number:
PW1681-IN

Invoice Date:
07 May 2024

Ship Date:
07 May 2024

SOLD TO:

Stanford University
Accounts Payable
P.O. Box 20410
Stanford, CA 94309-0410
United States

SHIP TO:

George Balazs -Independent
Sea Turtle Scientist
992 Awaawaanoa Place, Apt A
Honolulu, HI 96825
United States

Shipping	\$410.00
Sales Tax	\$0.00
Total Amount USD	<u>\$54,716.20</u>

4-13-24 SAME DAY

DP
新幹線指定券
RESERVED SEAT TICKET
岡山 → 名古屋
OKAYAMA → NAGOYA
APR 13 (15:36発) (17:42着) C40
HIKARI 516 GAR. 12 SEAT. 13-A
¥***

2024-4.12関西空港F12(4-夕) 20093-01
7345/1034-219758

指定券
RESERVED SEAT TICKET
宇多津 → 岡山
UTAZU → OKAYAMA
APR 13 (14:05発) (14:41着) C43
NAMPU 14 GAR. 3 SEAT. 10-A
¥***

2024-4.13宇多津MN (5-夕) 10638-01

世界各地にある6,000以上のホテルとリゾートで、会員限定の特典を楽しみ、ポイントを獲得しましょう。

今すぐ入会して、特典をご利用ください
IHG.COM/ENROLJPN

5 NIGHTS

Enjoy exclusive benefits and earn points at over 6,000 hotels and resorts worldwide.

JOIN NOW FOR INSTANT BENEFITS
IHG.COM/ENROLNOW

IN 4/13 / out 4/18
SAT / 2024 THURS

客室/Room: 1805

Wi-Fi/wi-fi: grandcourt

ANA CROWNE
KANAYAMA

OSAKI AIRPORT

- ▼ Haruka 6
- ▼ [Travel Time 58min]
- ▼ 9:05 SHIN-OSAKA
- ▼ 9:20 [Time Between Trains 14min]
- ▼ Sakura 649
- ▼ [Travel Time 50min]
- ▼ 10:10 OKAYAMA
- ▼ 10:35 [Time Between Trains 25min]
- ▼ Shikaze 7
- ▼ [Travel Time 32min]
- ▼ 17:07 UTAZU

---EMD---

departs 14:35 → arrives 17:42
travel time: 3hr 7min | transfer(s)
| 第3経路
| 4/13 14:35発→17:42着
| 所要時間 3時間07分 乗換回数 1回

Apr. 13
14:35 UTAZU

- ▼ Shikaze 18
- ▼ [Travel Time 38min]
- ▼ 15:11 OKAYAMA
- ▼ 15:36 [Time Between Trains 25min]
- ▼ Hikari 516
- ▼ [Travel Time 125min]
- ▼ 17:42 NAGOYA

---EMD---

2024/04/12 21:23 J

YAD 9075-10054120



Customer ID USTANFO	FOB Destination Ship Via	PO Reqd. - Net Due Upon Receipt	Terms	PO Number 63428446		
Item	Description	Quantity Ordered	Quantity Shipped	Back Ordered	Unit Price	Amount
AM-S387A-00	SPOT-387A, Backmount	29	29	0	1,450.00	42,050.00
AM-A297S-A-00	SPLASH10-297S -00, Rectangle Backmount, Standard depth range, Custom	3	3	0	3,300.00	9,900.00
AZ-USBA-004	Cable Assy USB-A "SPARK" rev.4, Sales price \$25 USD	3	3	0	0.00	0.00
ITAX-HAWAII GET 4.5%	Hawaii General Excise Tax 4.5%	1	1	0		2,356.20
BANK-SCB DOM	Prices are based upon payment by electronic funds transfer or check. Other payment methods may be assessed a handling fee of up to 4%. Our bank information for Domestic Wire Transfers is: Bank: Sound Community Bank 2400 3rd Ave, Suite 150 Seattle, WA 98121 Tel: 800-458-5585 ABA Number: 325081306 Account Number: 0039157376 Beneficiary Name: Wildlife Computers, Inc. Please reference the invoice number for identification purposes.				0.00	0.00

COPY

4-14-2024 SUNDAY

2024.04.14
八場券 大人
Adult (Age 19&up)

¥2,400



13:30 ~ 14:00

京都水族館 KYOTO AQUARIUM BY ONIX

●本券は1枚につき1名様、先着当日に限り有効です。●本券の払い戻し、換金および再発行はできません。●本券の転売はできません。●本券にて一度ご入場いただいた場合は無効となり、本館での再入場はできません。●再入場を希望される場合は出口のスタッフまでお申し出ください。●生き物を連れてのご入場はできません。●雨時や急のお客様に対しては混雑回避があった場合は、ご退場していただくことがあります。●館内では動物保護のため、一部エリアを除きフラッシュ撮影をご遠慮いただいております。

★伝票番号 02-00093 クレジット
チケットID 2024-0414-0200-0930-0010

MERCHANT 075-354-3130
ご利用日DATE 2024/04/14 13:44:04
カード番号CARD NO. Contactless IC
438857XXXXY4136

伝票番号	有効期限	取引内容
01524	XX年XX月	売上
SLIP NO.	EXP. DATE	TRAN. TYPE
支払区分	取扱区分	商品区分
一括	110	
PMT. TYPE	DOM. CODE	
端末番号TERMINAL	G0522-510-56047	
カード会社	MJFCカード (105)	
CARD COMPANY		
承認番号APPROVAL CODE	021674	
処理番号TRAN. NO.	498844	
金額AMOUNT	¥2,400	
△引△額		
□引□額	¥2,400	

UBAHA
Yamaguchi 7/7/24
N=6 N=22

Turtle No. Behavior just after the release

- #26 Dived down underwater
- #27 Dived down underwater
- #28 Stayed at the sea surface
- #29 Dived down underwater
- #30 Stayed at the sea surface
- #31 Dived down underwater
- #32 Dived down underwater
- #33 Dived down underwater
- #34 Dived down underwater
- #35 Stayed at the sea surface
- #36 Stayed at the sea surface
- #37 Dived down underwater
- #38 Dived down underwater
- #39 Dived down underwater
- #40 Dived down underwater
- #41 Dived down underwater. SPLASH GO
- #42 Dived down underwater
- #43 Dived down underwater
- #44 Dived down underwater
- #45 Dived down underwater
- #46 Dived down underwater
- #47 Dived down underwater
- #48 Stayed at the sea surface
- #49 Dived down underwater
- #50 Dived down underwater
- #51 Dived down underwater
- #52 Dived down underwater
- #53 Stayed at the sea surface

KYOTO SUNDAY 4-14-2024

(22)

新幹線指定券
RESERVED SEAT TICKET
名古屋 → 京都
NAGOYA → KYOTO
APR. 14 (11:43発) (12:34着) C55
KODAMA 711 CAR. 12 SEAT. 11-E

2024-4.14名古屋北東2 (3-) 00322-01

新幹線指定券
RESERVED SEAT TICKET
京都 → 名古屋
KYOTO → NAGOYA
APR. 14 (16:08発) (16:42着) C56
HIKARI 514 CAR. 14 SEAT. 14-E

2024-4.14京都東N22 (4-夕) 20408-01
7345/1034-219758

4/14/24

クレジット売上票
 加盟店名 ミスタドーナツ カナヤマ
 テン

MERCHANT 052-331-3859
 端末番号 TERM NO 66192-620-22517
 ご利用日 DATE 24/04/14 20:11:35
 会員番号 ACCT NO
 438857*****4036 IC
 カード会社 CARD COMPANY
 ビザ/マスター
 承認番号 APP CODE 0040540
 処理番号 TRAN NO 0769265

取引内容 売上 | 伝票番号 03208 | 有効期限 XX/XX

支払区分 一括 | 取扱区分 110 | 商品区分 0310

金額 AMOUNT **¥330**

MR. DONUT
 BALAZS/GEORGE 様

ご利用ありがとうございます
 またのご来店をお待ちしております
 ARC 00 ATC 0086 No. 03
 AID A000000031010
 APP LABEL VISA CREDIT
 売場SALES | 係員CLERK

GMO

TERMINAL 641
 承認番号 APPROVE No 013794
 処理通番 TRAN No 276837
 伝票番号 SLIP No 51459
 取引内容 SALES
 売上
 商品区分 GOODS CODE 990
 金額 AMOUNT ¥648
 △計額 **¥648**
 日計額] ARC 00
 AID [VISA CREDIT
 A000000031010
 ATC 00131 SEQ 03
 ご案内
 UJカード
 アドバドリ コーザイマシタ

<4000-5914-00-00-21> SL
 加盟店 JR東海リテリング・プラス

売場 0003 係員****
 SALES COUNTER CLERK
 ※は軽減税率(8%)対象商品
 登録番号: T8180001031531
 取引No:6967 1点買
 CARD Company UJカード VISA

お客様控え



PM TO KYOTO AQUARIUM SUNDAY 4/14/24 DINNER (24)

Birds!
When Feeding/when Measuring
Need Video CAMERA

M マクドナルド金山店
名古屋市中区金山4-6-25
052-321-3157
営業時間 24時間営業
登録番号: T5011101033703

TANK? Something about that one TANK
2024年4月15日 (月)

Hot Meal	500	13	¥500
YASAISEKATSU100 M	270	13	¥270
HOT APPLE PIE	140	13	¥140

See underside
Turtle Biting
from Top down?

合計	33		¥910
(内消費税)			¥82
10%対象			¥910
(内消費税)			¥82
合計			¥910
クレジット支払			¥910
おつり			¥0

クレジット
VISA/MasterCard
伝票番号 420
会員番号 *****4036
承認番号 0039134
基本ID 082468407553
A000000003101
VISA CREDI

GIANT SALAMANDER

SUSHI
[クレジット売上票] G
加盟店名 2味ワカヤミ KAWAYAMA
052-681-0041
端末番号 49664-560-38847
ご利用日 24/04/14 19:14:24
伝票番号 14561
202 会員番号 XXXXXXXXXXXX4036(10) -0001
承認番号 027344 3名
取引内容 支払区分 取扱区分
売上 一括 110
カード会社 有効期限
MFG01 XX/XX 1450
金額 ¥5,880 1800
△計金額 ¥5,880
BALAZS GEORGE 500
ご利用ありがとうございます 750
またのご来店お待ちしております
A0000000031010
S512315 C03 A00132 VISA ¥800
売場: 係員: ¥580
00
23c44e8f2f7f8e8e
INFOX 80
お客様控え 534
534
880

番号 T3180001030447
会計担当 松田
オーダー担当 松田
No0156326

潜水の深さ、水温も調査へ

北太平洋におけるアカウミガメの回遊経路を調べる名古屋港水族館（名古屋市港区）の共同研究が2年目に突入した。来月中旬に2歳弱の28匹を海上で放流。今年は位置情報に加え、潜水の深さや水温が分かる送信機も取り付け、より詳細な分析を目指す。

研究には他に米国、メキシコ、ニュージーランドの機関が参加。アカウミガメが水温上昇に伴い、北太平洋中部から北米西海岸に向けて回遊するという仮説を5年間で検証し、効果的な保護活動につなげる。

昨年は放流した25匹のうち、7匹が北米大陸に向けて泳ぎ、3匹が西海岸にたどり着いた。エルニーニョ

現象による海水温上昇の影響を受けたとみられ、米スタンフォード大学のクワウター教授(74)は「海水温の高い場所には餌が多く、経路とすることが多い」と解説する。

19日には、同館で研究者や学生が40秒前後のアカウミガメの甲羅に、送信機を樹脂などで装着した。クワウター教授は「今年はエルニーニョ現象による海水温低下が予想され、北米大陸に向かう個体はいないと思う」と推測。同館の森昌範さん(49)は「国際チームと連携して、日本代表の水族館として携わってきたい」と話した。

（赤塚一輝）

4/15/2024
MONDAY

"TOMO"

(26)

PREVIOUSLY WITH OACA
NET -

TO PNPA 10 AM



PORT OF NAGOYA
PUBLIC AQUARIUM



Sea Turtle Section

Matsumoto Tomomi

Nagoya Port Foundation

1-3 Minato-machi, Minatoku, Nagoya 455-0033 Japan

TEL +81-52-654-7080

FAX +81-52-654-7001

t-ogawa@nagoyaminato.or.jp

アカウミガメに送信機を装
着する研究者ら。名古屋市
港区の名古屋港水族館で



6/26 中日朝刊

PNPA TO YOKOHAMA 4-15-2024 MONDAY
 X PM

!!
 JUST
 FOR
 THE 97
 RIDE

TO
 THINK
 ABOUT
 TURTLES

4/15/24 新幹線指定券
 RESERVED SEAT TICKET
 名古屋 → 新横浜
 NAGOYA → SHIN-YOKOHAMA
 APR. 15 (14:31発) (15:54着)
 HIKARI 652 CAR. 12 SEAT. 3-A C52
 ¥***

2024-4-15名古屋駅南乗1 (3-) 20513-01

4/15/24 新幹線指定券
 新横浜 → 名古屋
 SHIN-YOKOHAMA → NAGOYA
 4月15日 (16:21発) (18:01着)
 ひかり 519号 15号車 6番A席 C12
 ¥***

2024-4-15新横浜駅南942(3-) 50579-01

FamilyMart

名古屋港店
 愛知県名古屋市港区入船2-3-3

電話: 052-659-1331

登録番号: T1180002054158

2024年 4月15日 (月) 9:55
 領収書 No. 012

領収証

ハムたまごサンドBOX ¥368
 値下 -30
 オレンジ ¥268
 (商品会計 ¥636)
 (値引合計 -30)
 合計 ¥606
 (8%対象 ¥606)
 (内消費税等 ¥44)
 クレジット支払 ¥606
 「軽」は軽減税率対象商品です。

クレジット支払

取引日 2024年 4月15日
 伝票番号 CL 29860
 会員番号 **** * 4036
 会社名 VISA
 承認番号 06625D
 支払区分 一括
 支払金額 ¥606
 AID A000000031010

お客様控え

売場
 SALE
 ※は
 登録
 取引

June 2024

28

お客様控 クレジットカードご利用票 / CREDIT CARD SALES SLIP R117

会社名・会員番号 UC-XXXXXXXXXXXX4036 有XX-XX (JR東海)
取引内容:お買上 支払区分: - 一括 IC ￥9,880

承認番号:09001DATC008 C03
商品名: (一括発券)乗車券類 3枚(兼)
6月23日 こだま 733号 静岡→名古屋 乗車券込み 他
乗車変更や払戻しの取扱箇所、内容、方法等に制限があります。
払戻しの際は購入時のカードをお持ちください。
VISA CREDIT A0000000031010 この控は大切に保存してください。
2024-6-23 40445-05 静岡駅MR003発行

お客様控 クレジットカードご利用票 / CREDIT CARD SALES SLIP R101

会社名・会員番号 UC-XXXXXXXXXXXX4036 有XX-XX (JR東海)
取引内容:お買上 支払区分: - 一括 IC ￥9,700

承認番号:02569DATC009 C03
商品名: (一括発券)指定券 2枚(兼)
6月23日 ひかり 502号 名古屋→静岡 乗車券込み
乗車変更や払戻しの取扱箇所、内容、方法等に制限があります。
払戻しの際は購入時のカードをお持ちください。
VISA CREDIT 60000000031010 この控は大切に保存してください。
2024-6-22 20639-04 (中) 金山駅MR2発行

新幹線指定券
RESERVED SEAT TICKET
名古屋 → 米原
NAGOYA MAIBARA
JUN. 22 (10:43発) (11:10着) C43
KODAMA 707 CAR. 14 SEAT. 5-E

2024-6-22(中) 金山駅MR1(3-) 40235-01 7345/1733-470377

新幹線指定券
RESERVED SEAT TICKET
米原 → 京都
MAIBARA KYOTO
JUN. 22 (12:53発) (13:12着) C30
HIKARI 639 CAR. 6 SEAT. 10-E

2024-6-22米原駅MR911(3-) 20338-01

新幹線指定券
RESERVED SEAT TICKET
京都 → 名古屋
KYOTO NAGOYA
JUN. 22 (15:33発) (16:25着) C05
HIKARI 656 CAR. 12 SEAT. 13-E

2024-6-22(女) 京都MR15(3-) 30451-01 71531-904 7345/1733-470377

4/16/24 指定券 TUESDAY
NAGOYA
名古屋 → 敦賀
4月16日 (7:51発) (9:27着) C35
しりさき 1号 3号車 9番A席

2024-4.14(中) 金山線MR1(3-夕) 00567-01

4/16/24 新幹線指定券 KAWAZAWA
敦賀 → 金沢
4月16日 (9:46発) (10:43着) C33
つるぎ 8号 5号車 9番A席

2024-4.14(中) 金山線MR1(3-夕) 00567-02

指定券 4/16/24 NAGOYA
敦賀 → 名古屋
4月16日 (18:08発) (19:46着) C25
しりさき 14号 3号車 12番D席

2024-4.14(中) 金山線MR1(3-夕) 00567-04

SHINKANSEN 4/16/24
KAWAZAWA 新幹線指定券
金沢 → 敦賀
4月16日 (16:54発) (17:36着) C43
つるぎ 35号 5号車 10番E席

2024-4.14(中) 金山線MR1(3-夕) 00567-03

JUNE 2024

新幹線指定券
RESERVED SEAT TICKET
名古屋 → 静岡
NAGOYA → SHIZUOKA
JUN 23 (10:43発) (11:37着) C00
HIKARI 502 CAR-12 SEAT-3-A

2024-6.22(中) 金山線MR2(3-) 00630-01
7345/1733-470377

新幹線指定券
RESERVED SEAT TICKET
静岡 → 名古屋
SHIZUOKA → NAGOYA
JUN 23 (15:52発) (17:06着) C20
KODAMA 733 CAR-13 SEAT-18-B S

2024-6.23静岡線MR003(3-) 00441-01
7345/1733-470377

新幹線指定券
RESERVED SEAT TICKET
名古屋 → 浜松
NAGOYA → HAMAMATSU
JUN 21 (19:08発) (19:53着) C24
KODAMA 748 CAR-12 SEAT-10-A

70974-423

新幹線指定券
RESERVED SEAT TICKET
浜松 → 名古屋
HAMAMATSU → NAGOYA
JUN 21 (21:39発) (22:11着) C04
HIKARI 663 CAR-12 SEAT-12-E

2024-6.21浜松線MR004(3-) 00354-01
7345/1733-470377

4-16-2024

(30)

TUESDAY - KAWAZAWA
PM VIA TSURUGA

(As of 3/24 new SHINKANSEN)

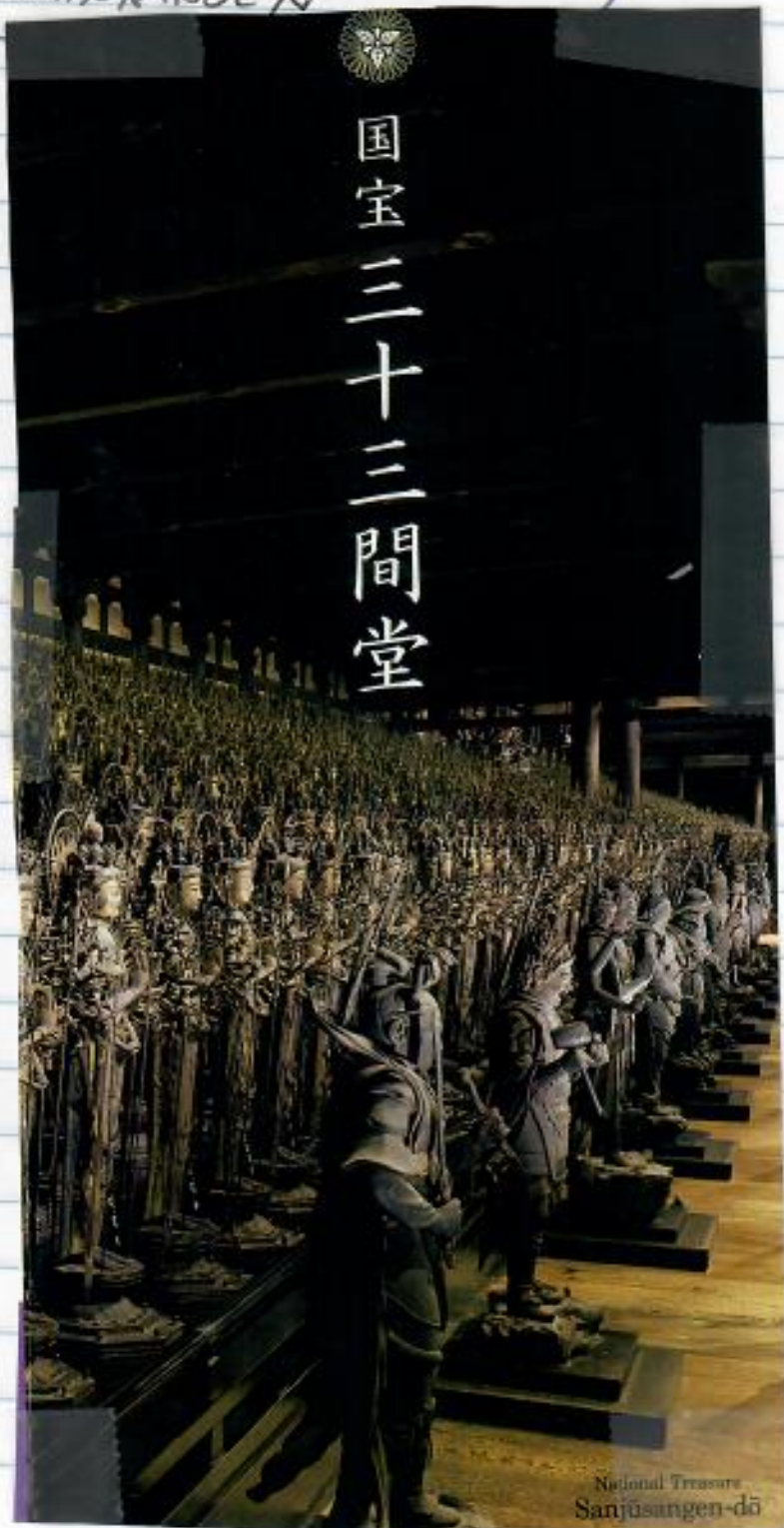

4/16/2024 TUESDAY KAWAZAWA

マクドナルド金 山 店
名古屋市中区金山4-6-25

052-321-3157

営業時間 24時間営業

登録番号: 15011101033783

4/16/24 Monday Dinner

65 V*NO 23 2024年4月16日 (火) 21:07

FILET-O-FISH	420	11	¥420
YASAISEIKATSU100 M	270	11	¥270
HOT APPLE PIE	140	11	¥140

小計	33	¥830
(内消費税)		¥75
10%対象		¥830
(内消費税)		¥75
合計		¥830
クレジット支払		¥830
おつり		¥0

クレジット
VISA/MasterCard CL売上

伝票番号 1297
会員番号 *****4036
承認番号 0048054
上位端末ID 0824684075530
ATD A0000000031010
VISA CREDIT

季節料理 おでん

黒百合

黒百合 076-260-3722
石川県金沢市木ノ新保町1-1 金
T印は軽減税率適用商品

2024年 4月16日(火)16時06分000101

白山定食 ¥2,200内
生ビール 中ジョッキ ¥680内
伝票No. 31139 チーフNo. 23

小計額	¥2,880
(10%内税対)	¥2,880
(10%内税額)	¥261
(消費税対象額)	¥2,880
(消費税等)	¥261
合計	¥2,880
クレジット計	¥2,880
合計点数	2点

軽: 印は軽減税率(8%)適用商品
登録番号 T5220001006564

01 扱責任者 No. 4302 1名



Route 1
 Apr. 16: departs 7:51 → arrives 10:43
 Travel Time: 2hr52min | transfer(s)
 | 第1経路
 | 4/16 7:51発→10:43着
 | 所要時間 2時間52分 乗換回数 1回

Apr. 16
 7:51 MAGOYA
 ▼
 Shirasagi 1
 [Travel Time 95min]
 9:27 TSURUGA ←
 9:45 [Time Between Trains 19min]
 ▼
 Utsunomiya
 [Travel Time 57min]
 ▼
 10:43 MAGOYA
 END

SHINKANSEN

Utsunomiya

ASAKUKAWA

2024/04/14 17:18 JR東 計7MR1

Route 1
 Apr. 16: departs 16:54 → arrives 19:46
 Travel Time: 2hr52min | transfer(s)
 | 第1経路
 | 4/16 16:54発→19:46着
 | 所要時間 2時間52分 乗換回数 1回

Apr. 16
 16:54 KANAZAWA 454 PM
 ▼
 Tsurugi 10
 [Travel Time 42min]
 17:35 TSURUGA
 18:08 [Time Between Trains 33min]
 ▼
 Shirasagi 14
 [Travel Time 96min]
 ▼
 19:46 MAGOYA 746 PM
 END

2024/04/14 17:19 JR東 計7MR1

Tokaido Route
 4174033 各駅停車
 TEL: 052-634-7094 (JR東)
 URL: www.jreast.co.jp
 Mail: tokaido@jreast.co.jp

13

**PORT OF NAGOYA
PUBLIC AQUARIUM**

YUKAKO ODANI
VETERINARIAN

1-3, Minato-machi, Minato-ku, Nagoya 455-0033 JAPAN
Phone 052.654.7080 Fax 052.654.7001
Email y-odani@nagoyaminato.or.jp

OVER ♀

**PORT OF NAGOYA
PUBLIC AQUARIUM**

TAKASHI KAMIO
VETERINARIAN

1-3, Minato-machi, Minato-ku, Nagoya 455-0033 JAPAN
Phone 052.654.7080 Fax 052.654.7001
Email t-kamio@nagoyaminato.or.jp

OVER

4/16/24

455-0033 名古屋港区港町1-3
TEL 052-654-7094 (直通)
FAX 052-654-7001
Mail y-odani@nagoyaminato.or.jp



小谷由佳子
Yukako Odani

公益財団法人 名古屋文化振興財団
名古屋港水族館
飼育展示部 飼育展示第三課
衛生管理担当 獣医師



4550033 名古屋港区港町1-3
TEL 052-654-7094 (直通)
FAX 052-654-7001
Mail t-kamio@nagoyaminato.or.jp



神尾高志
Takashi Kamio

公益財団法人 名古屋文化振興財団
名古屋港水族館
飼育展示部 飼育展示第三課
衛生管理担当 獣医師



OVER ♀

OVER

20

KAW

4/16/24
C

2024-4

AP

SUBWAY STOPS

- ↓ KANAYAMA 4/17/24
- 1) HIBINO TUES
- 2) ROKUBANCHI
- 3) TOKAI-DORI
- 4) MIATOKUYAKU SHO
- 5) TSUKIJIGUCHI
- 6) NAGOYAKO (E7)
- 7)

Apr 17
 departs 14:04 → arrives 15:25
 travel time: 1hr 21min 2 transfer(s)
 | 第3线路
 | 4/17 14:04発-15:25着
 | 所要時間 1時間21分 乗換回数 2回

Apr 17
 14:04 KANAYAMA ✓
 ▼ Tokaido Line
 [Travel Time 6min]
 MAGOYA
 [Time Between Trains 9min]
 ▼ ~~Hikari 043~~ Go To NAGOYA By
 33 MISTAKE
 TOKYO
 [Travel Time 28min]
 14:47 MAIBARA
 14:59 [Time Between Trains 12min]
 ▼ Tokaido-San-yo Line
 [Travel Time 26min]
 15:25 OMIHACHIMAN ✓
 -----END-----

2024/04/17 09:39 JRE

 ANA
 CROWNE PLAZA
 AN IHG HOTEL
 HOTEL GRAND COURT NAGOYA

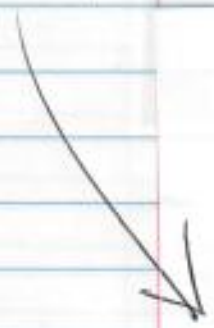

OMI HACHIMAN
 STATION # A19

Then local RAPID KYOTO → OMIHACHIMAN

36

Yok. By MISTAKE
NOZOKI 新幹線指定券
 RESERVED SEAT TICKET
 名古屋 → 米原
 NAGOYA → MAIBARA
 APR. 17 (14:19発) (14:47着) C03
 HIKARI 643 CAR. 14 SEAT. 9-E
 4/17/24
 2024-4-17(中) 金山駅MR2(3-) 60118-01

16:03
KODAMA 新幹線指定券
 RESERVED SEAT TICKET
 米原 → 名古屋
 MAIBARA → NAGOYA
 APR. 17 (19:33発) (20:01着) C03
 KODAMA 752 CAR. 14 SEAT. 8-E
need 16:03-18:26 HARUKA 45 4-18
 2024-4-17(中) 金山駅MR2(3-) 60118-02

9:07 → arrives 20:16
 9min 2 transfer(s)
 第2経路
 4/17 19:07発→20:16着
 所要時間 1時間09分 乗換回数 2回

Apr. 17
 19:07 OMIHACHIMAN ←
 ▼ Tokaido-San-yo Line [Travel Time 19min]
 ▼ MAIBARA
 19:26 MAIBARA
 19:33 [Time Between Trains 7min]
 ▼ dane 752 [Travel Time 28min]
 ...JYA
 20:13 [Time Between Trains 18min]
 ▼ Tokaido Line [Travel Time 3min]
 ▼ KANAYAMA
 -----END-----

4/17/24 wed!

2024/04/17 09:3

OMIHA CHIMAN
STATION

加
旧
力
伝
端
こ
力
有
印
支
商
女
ノ
ミ
テ

TAXI TO
LAKE BIWA

クレジットカード売上
お客様控

加盟店名 0759
電話番号 0748-2
伝票番号
端末番号 90864-584
ご利用日 2024/04/17
クレジット会社
会員番号 (IC) XXXXXXXXX
承認番号
取引内容
支払区分
KID 有効期限
105 26/08
カード番号: 03 A T C
A I D VISA
A000000
金額 3,
税その他
合計金額 Total Yen

商品名/型式
数量
担当者名
お知らせ
ご利用ありがとうございます

9レコ

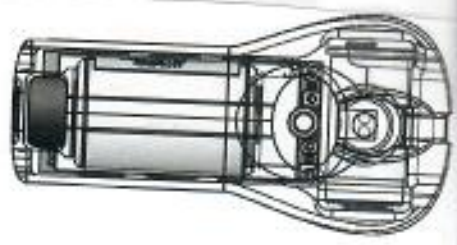

WET/DRY SENSOR

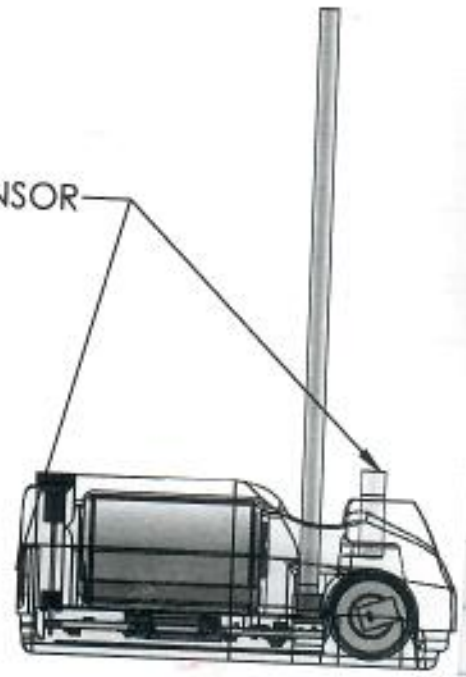

38

ARGOS ANTENNA;
(length not to scale)

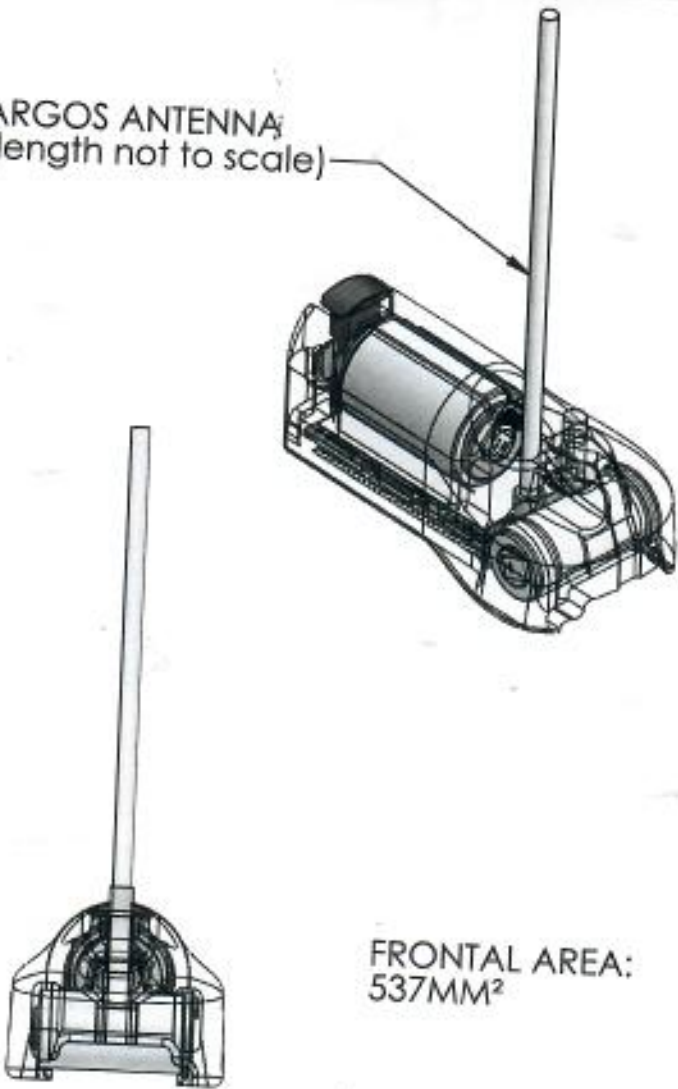

FRONTAL AREA:
537MM²

		Wildlife Computers	
		SPOT-387A, Backmount	
DIMENSION L x W x PD	59 x 29 x 23mm	SIZE	DWG. NO.
		A	AM-S387A-00
WEIGHT IN AIR	39 g	DRAWN	NAME
			AFL
PRESSURE RESISTANCE	500m	DATE	8/17/2018
		SCALE: 1:1	SHEET 1 OF 1
ATTACHMENT	Backmount	DO NOT SCALE DRAWING	

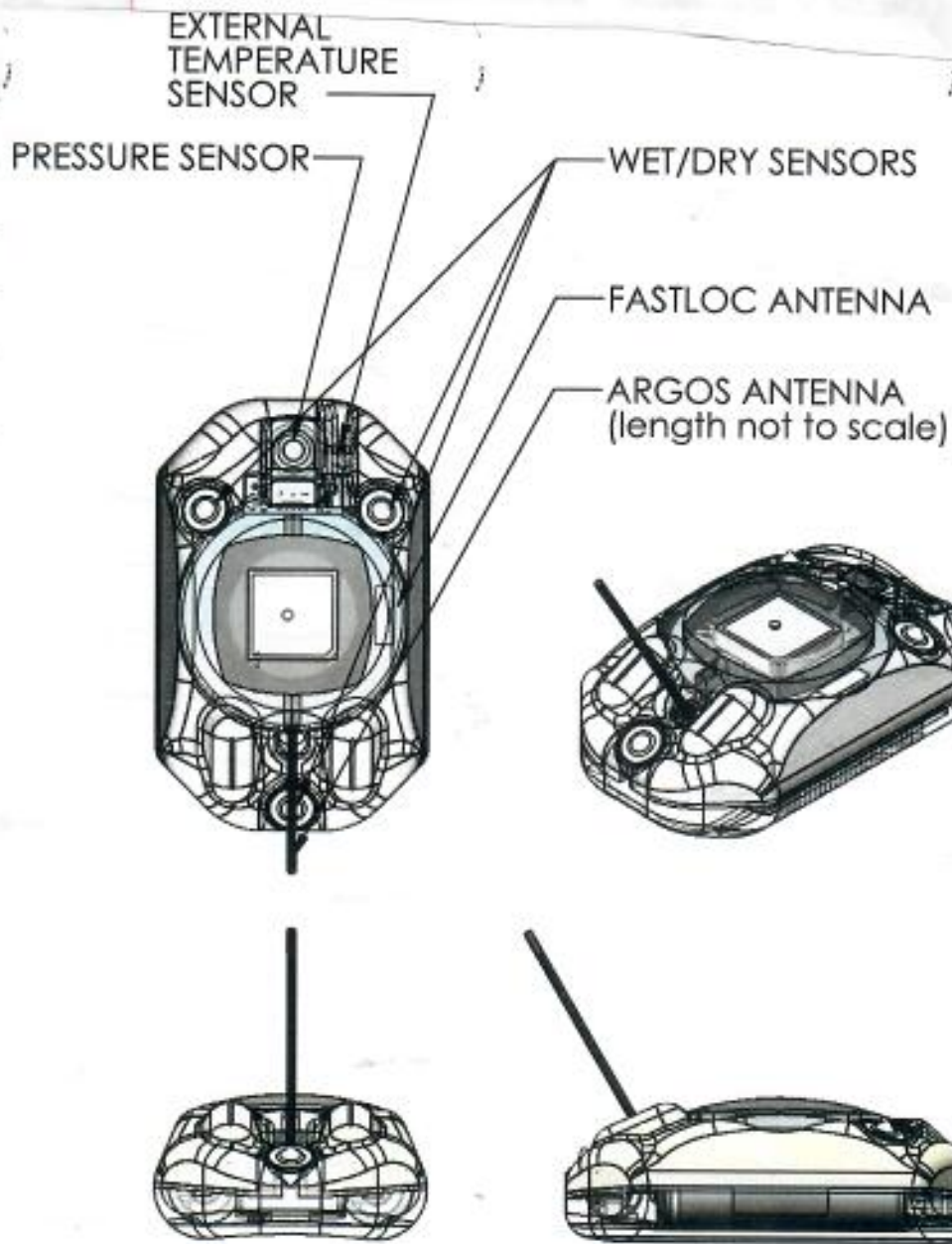

Wildlife Computers Proprietary Drawing
Not to be reproduced, copied, or used as the basis
for manufacture or sale without written permission.

4-18-2024
Thursday

(40)

15 TANK 2 For Tank
3 TANK 1 NOT STRETCH near tank

15 IN TRAY Chelonia Institute
Photo of EACH TAKEN w/ MOTO 6

Thursday
4/18/24 (3 white)
15 TANK 2
3 IN TANK 1
NOT stretch

w/TOMORROW
15 Chelonia
Insti
7 TRAYS
DRY

~~25 + 3~~
~~28~~
2 EXTRA
30 total STRETCH
Need
X RAYS
of 3
WORSE

041

YAMASHITA HIROSHI
Turtle caretaker PNPA
Met w TOMO 4/18/24 Thursday

TABLE 1. AM NUMBER AND HARDWARE.

AM NUMBER	CAPABILITIES
AM-A297N-AF-00	ARGOS, DEPTH, TEMPERATURE, FASTLOC
AM-A297O-AFB-00	ARGOS, TEMPERATURE, FASTLOC
AM-A297P-F-00	DEPTH, TEMPERATURE, FASTLOC
AM-A297S-A-00	ARGOS, DEPTH, TEMPERATURE
AM-A297T-AX-00	ARGOS, DEPTH, TEMPERATURE, ACCELEROMETER

SPLASH 10

NOTE: VARIANTS OF THE 297 WILL HAVE DIFFERENT EXTERNAL HARDWARE DEPENDING ON THEIR CAPABILITIES. PLEASE REFER TO TABLE 1 FOR THE CAPABILITIES OF EACH VARIANT.



**Wildlife Computers
A297 DRAWING**

DIMENSION (L X W X H)	SIZE	DWG. NO.	REV.
86 x 55 x 29mm	A	AM-A297	-
WEIGHT IN AIR	128 g	DRAWN NAME	PN
PRESSURE RESISTANCE	2000m	DATE	09-AUG-23
ATTACHMENT	BACKMOUNT	SCALE: 2:3	SHEET 1 OF 1
DO NOT SCALE DRAWING			

4-18-2024 Thurs

PNPA (42)

- Supplies inventory by GHB
 In Cardboard Boxes (2) BOXES 1 & 2
- 1 - WC Epoxy Kit worthless
 - 1/2 Pint Ethanol
 - 1/4 Roll Blue Tape
 - 1 - Hinge Pliers
 - 1 - 6/12 DATE Elastomer KIT
 - MANY - STIR STICKS
 - MANY - SAND PAPERS #100 + #60
 - 25 RED Shop towels
 - 9 - 1 QUART ZIP LOCK BAGS
 - ~50 Chopstick STIRRING
 - 14 BRUSHES 1"
 - 1 - ENVELOPE Accelerator POWDER
 - 4 - SCAPERS
 - 11 - Paper cups
 - 19 - PLASTIC CUPS
 - 2 Biopsy Punch 6MM
 - 3 WHATMAN Genetics SAMPLERS

2024

XRAY

5328

5329

5330

5332

X-RAY

APRIL



MAY



JUNE

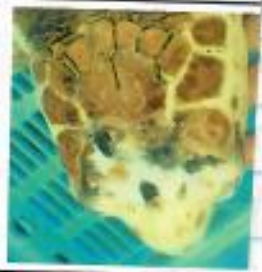

NOTE: VARIANTS

HARD TO SEE

Wildlife Computers

A277 DRAWING

128

AM-A277

128

DO NOT SCALE DRAWING

4-18-2024

Thursday

(44)

BOXES 3 & 4 AT PNPA INVENTORY

- Ethanol x 2 partially bottles
- 1 - Resin new (good?)
 - 1 - 1/2 Container Bottom paint (Dried) (UP?)
 - 2 - UV Ring Repair
 - (50) - AUBBA Gloves
 - 1 - UV Flash Lite
 - ~15 Towels white
 - ~12 AA's Batteries
 - (2) Kits ELASTOMO
 - (75) 1" Brushes
 - 2 - Cutters BLADE
 - 1 - UV GLASSES Protective

1024

5284

X-RAY

5285

5286

5326

5327

APRIL



MAY



JUNE



4-18-2024

PAGE 3 of 3

SUPPLIES

Suitcase AT PURA GB
INVENTORY

(46)

- 2 - UV ^{protective} Glasses
- 1 - Small Hack Saw
- (3) BAGS of Rubber gloves
- (1) ELASTOMER KIT
- 1 - Sissors
- 1 - Sushi knife
- 1 FULL Roll 3" Blue tape
- 60 1" Brushes
- 1 Bag misc Fiberglass Cloth

★ MAJOR ITEMS NEEDED FOR JUNE 2024 ★

- * ROLLS of CLOTH TAPE 3" & 1"
- + RUBBER GLOVES (different sizes)
- + ELASTOMER KITS (have 3)
- + BRUSHES Need 12 New
96 1" wide
- + MIXING CUPS
- + DIGITAL THERMOMETER
- + NUMBERED LABELS
- * "O" to protect recess at antenna base
- FROM KURITA-SAN
- Resin
- Bottom Paint



George Balazs

To: STRETCH Google Groups; Mon 5/20/2024 6:42 PM

Happily, here are our 5 Hawaiian names (with meanings in English) envisioned by our Hawaiian Cultural Specialist, Honu Caretaker, and friend, Pi'i Laeha.

HO'OKELE - navigator

MOANA KAI - deep open seas

HOKU PA'A - fixed North star

HO'O MAU - persistent, keep on going

KAHIKINA - to the East

I hope these names help!

Malama pono,

Pii

P.I.E. H.A. APP.1

ACCESS

6/2024





改札から 1分



米原駅サイクルステーション

(48)

	5278	5280	5282 X-RAY	5283
20-Apr 2024				
21-May 2024				
5-Jun 2024				

50

新幹線指定券
RESERVED SEAT TICKET

名古屋 → 新大阪
NAGOYA → SHIN-OSAKA

APR. 18 (16:03発) (16:57着) C53
HIKARI 515 CAR. 14 SEAT. 20-E

¥***

2024-4.18(中) 金山駅 乗2(3-) 20191-01

指定券
RESERVED SEAT TICKET

新大阪 → 関西空港
SHIN-OSAKA → KANSAI AIRPORT

APR. 18 (17:28発) (18:26着) C60
HARUKA 45 CAR. 4 SEAT. 12-D

¥***

2024-4.18(中) 金山駅 乗2(3-夕) 20191-02

JAPAN RAIL PASS
(ORDINARY 7DAYS) 567 -01

2024-4.13~2024-4.19
YEAR-MONTH-DAY (普通車 7日専用)

This pass is non-resalable. Insert it in ticket sales and don't forget to take it.

¥50000(前)
(4-夕) 00088-01 C50

7345/1034-219758 2024-4.18 関西空港 乗5 12発行

Apr 18: departs 16:03 → arrives 18:26
Travel Time: 2hr23min | transfer (a)
| 第1経路
| 4/18 16:03発-18:26着
| 所要時間 2時間23分 乗換回数 1回

Apr 18
16:03 NAGOYA
▼
▼ Hikari 515
▼ [Travel Time 54min]
▼
16:57 SHIN-OSAKA
17:28 [Time Between Trains 31min]
▼
▼ Haruka 45
▼ [Travel Time 60min]
▼
KANSAI AIRPORT
---END---

4/18/24
Thursday

TK2050 4/18/24
クレジット利用明細(お客様控)

STARBUCKS[®]

金山橋南口店
#385 TEL 052-678-1471

1 Sドリップ コーヒー	346
1 あらびきサセーザルイ E-テイク	328 (お支払)
1 アジカンクワッス お取り	264 0
E-テイク	(お支払)
本体合計(3点)	938
(10%対象)	938
消費税	93
総合計	1,031

三井住友(V/M) 1,031
お釣り 0

カード会社 三井住友(V/M)
会員番号 438857XXXXX4036
有効期限 XX年XX月
支払方法 一括払い
承認番号 087554
処理通番 38078
伝票番号 04853
AID A0000000031010
Application Label VISA CREDIT

240
「軽」印は軽減税率(8%)適用商品 For Here
020126604002 325404 2024/04/18 09:56:26

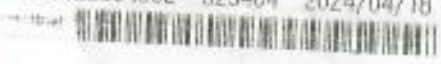

No. 5277

Sampling day: 2024/3/23

Culture identification
 ① Vibrio sp.
 ② Shewanella putrefaciens
 3+
 Aerobic culture: negative

S: Susceptible
 I: Intermediate
 R: Resistance
 N: No Data

Antibiotic Susceptibility Testing		
CLSI standards		
	①	②
AMPIC	S	R
ERIC	S	S
CHL/AMPC	S	R
CEX	S	R
OBM	S	R
CAZ	S	S
CTXK	S	S
CDTX	S	S
CPXK	S	R
CPXK	S	R
CPFM	S	R
CCOP	S	S
IPM	S	S
MEPM	S	S
MEPM	S	R
IFPM	S	R
EM	R	N
CBM	M	R
ADM	N	M
CLDM	R	N
LFLX	S	S
MPR	S	S
OFLB	S	S
DPXK	S	S
TLXK	S	S
LVXK	S	S
BRXK	S	S
PDR	S	R
PLFX	S	S
GRFX	S	S
STXK	S	S
DOXY	S	S
MIND	S	S
TOB	S	S
AMK	S	S
GM	S	S
ST	S	S
FCM	S	I

No. 5278

Sampling day: 2024/3/23

Culture identification
 ① Vibrio sp.
 ② Shewanella putrefaciens
 ③ Citrobacter freundii
 2+
 3+
 Aerobic culture: negative

S: Susceptible
 I: Intermediate
 R: Resistance
 N: No Data

Antibiotic Susceptibility Testing			
CLSI standards			
	①	②	③
AMPIC	S	R	R
ERIC	S	S	S
CHL/AMPC	S	R	R
CEX	S	R	R
OBM	S	R	R
CAZ	S	S	S
CTXK	S	S	S
CDTX	S	R	S
CPXK	S	R	S
CPFM	S	R	S
CCOP	S	S	S
IPM	S	S	S
MEPM	S	S	S
MEPM	S	R	S
IFPM	S	R	S
EM	N	N	N
CBM	M	N	N
ADM	N	M	N
CLDM	N	N	N
LFLX	S	S	S
MPR	S	S	S
OFLB	S	S	S
DPXK	S	S	S
TLXK	S	S	S
LVXK	S	S	S
BRXK	S	S	S
PDR	S	S	S
PLFX	S	S	S
GRFX	S	S	S
STXK	S	S	S
DOXY	S	S	S
MIND	S	S	R
TOB	S	S	R
AMK	S	S	S
GM	R	S	S
ST	S	S	S
FCM	R	I	S

No. 5286

Sampling day: 2024/3/23

Culture identification
 ① Vibrio sp.
 3+
 Aerobic culture: negative

S: Susceptible
 I: Intermediate
 R: Resistance
 N: No Data

Antibiotic Susceptibility Testing		
CLSI standards		
	①	
AMPIC	S	
ERIC	S	
CHL/AMPC	S	
CEX	S	
OBM	S	
CAZ	S	
CTXK	S	
CDTX	S	
CPXK	S	
CPFM	S	
CCOP	S	
IPM	S	
MEPM	S	
MEPM	S	
IFPM	S	
EM	N	
CBM	N	
ADM	N	
CLDM	N	
LFLX	S	
MPR	S	
OFLB	S	
DPXK	S	
TLXK	S	
LVXK	S	
BRXK	S	
PDR	S	
PLFX	S	
GRFX	S	
STXK	S	
DOXY	S	
MIND	S	
TOB	S	
AMK	S	
GM	S	
ST	S	
FCM	S	

No. 5328

Sampling day: 2024/3/28

Culture identification
 ① Vibrio sp.
 ② Shewanella putrefaciens
 2+
 3+
 Aerobic culture: negative

S: Susceptible
 I: Intermediate
 R: Resistance
 N: No Data

Antibiotic Susceptibility Testing		
CLSI standards		
	①	②
AMPIC	R	R
ERIC	S	S
CHL/AMPC	S	R
CEX	S	R
OBM	S	R
CAZ	S	S
CTXK	S	S
CDTX	S	S
CPXK	S	R
CPFM	S	R
CCOP	S	S
IPM	S	S
MEPM	S	S
MEPM	S	R
IFPM	S	R
EM	N	N
CBM	N	N
ADM	M	R
CLDM	N	M
LFLX	S	S
MPR	S	S
OFLB	S	S
DPXK	S	S
TLXK	S	S
LVXK	S	S
BRXK	S	S
PDR	S	S
PLFX	S	S
GRFX	S	S
STXK	S	S
DOXY	S	S
MIND	S	S
TOB	R	S
AMK	R	S
GM	R	S
ST	S	S
FCM	R	I

No. 3353

Sampling date: 2024/9/25

Culture Identification

- ① Vibrio sp. 3+
- ② *Chromobacterium* 1+
- ③ *Shewanella putrefaciens* 1+

Anaerobic culture: negative

Antimicrobial Susceptibility Testing

CLSI standards	①	②	③
AMPIC	S	R	R
PPC	S	S	R
CMV/AMPC	S	R	R
CEX	S	R	R
CRM	S	S	R
CAZ	S	S	R
CTRX	S	S	S
GDTR	S	S	R
OPOL	S	S	R
OPRM	S	R	S
LEOP	S	S	S
PM	R	S	S
MPCM	S	R	S
HRPM	S	R	R
EM	R	R	R
CAM	R	R	R
ARM	R	R	R
CLDM	R	R	R
LPX	S	R	S
HPX	S	S	R
OPUL	S	S	S
OPYK	S	R	S
THUX	S	S	R
LMR	S	S	R
PRYS	S	S	S
SRX	S	R	S
PLUX	S	S	R
OPFX	S	S	S
OPY	S	R	R
DOXT	R	R	R
MIND	S	I	S
TOB	S	S	R
AMN	R	S	S
DM	S	R	S
ST	S	S	R
PCM	R	S	R

S: Susceptible
 I: Intermediate
 R: Resistance
 N: No Data

Vibrio sp.

"CAZ"

CEFTAZIDIME

Abstract PICES Honolulu 10/2024

The North Pacific Transition Zone (NPTZ) is known as a global marine hotspot for many endangered and commercially significant highly mobile marine species. In the last few decades, the region has undergone unprecedented physical and biological transformations in response to climate variability and change. Although it is anticipated that many highly mobile species will need to adapt and shift their distributions, current predictions have relied on short-term data sets or modeled simulations. This has left a critical gap in our understanding of long-term (decadal or longer) change and species' responses within the NPTZ. Here, we integrate nearly 3 decades of satellite tracking data from a climate sentinel, the North Pacific juvenile loggerhead sea turtle (*Caretta caretta*), with concurrent observations of sea surface temperature (SST) and chlorophyll concentrations to examine higher trophic level response to climate-induced changes within the eastern bounds of the NPTZ. Between 1997-2024, the NPTZ has warmed by 1°C and experienced a 29% decline in mean surface chlorophyll concentration, corresponding to a loss of approximately 1 million km^2 of productive habitat. Over the same period, the average latitude of loggerhead sea turtle foraging habitat in the NPTZ has shifted northwards by 400-600 km, tracking the movement of the NPTZ in the same direction. This distributional shift rate (200km/decade) greatly exceeds the global average. Our findings reveal substantial physical and biological change to the NPTZ over the last quarter century and the first empirical evidence illustrating the substantial spatial response of a highly mobile apex species. As the NPTZ continues to undergo significant change, these insights can provide vital information for dynamic conservation and management strategies within this critically important ecosystem.

Conference: PICES 2024: Oct 26-Nov 1, Honolulu, HI

Presentation Type: Oral

Session: **S7, BIO/HD Topic Session** -- Social, economic and ecological implications of recoveries, range expansions and shifting distributions of marine birds, mammals and fish

Title

Multi-decade northward shift of loggerhead sea turtle pelagic habitat as the eastern North Pacific Transition Zone becomes more oligotrophic

Dana K. Briscoe^{1,2*}, Larry B. Crowder¹, George H. Balazs³, Jeffrey A. Seminoff⁴, Alberto Abreu⁵, Masanori Kurita⁶, Masanori Mori⁶, Denise M. Parker⁷, Marc R. Rice⁸, Tomomi Saito⁹, Bianca S. Santos¹, Calandra N. Turner Tomaszewicz⁴, Noah Yamaguchi⁹, Jeffrey J. Polovina¹⁰

*Presenting author

¹ Stanford University, Woods Institute for the Environment, Stanford, California, United States

² University of California Santa Cruz, Institute of Marine Sciences, Santa Cruz, California, United States

³ Golden Honu Services of Oceania, Honolulu, Hawaii, United States

⁴ NOAA-Southwest Fisheries Science Center, La Jolla, California, United States

⁵ Laboratorio de Genética, Unidad Académica Mazatlán, Instituto de Ciencias del Mar y Limnología, Universidad Nacional, Autónoma de México, Mazatlán, Sinaloa, Mexico

⁶ Port of Nagoya Public Aquarium, Minato-ku, Nagoya, Japan

⁷ Golden Honu Services of Oceania, Newport, Oregon, United States

⁸ Hawaii Preparatory Academy, Kamuela, Hawaii, United States

⁹ Usa Marine Biological Institute Kochi University, Usa Tosa, Kochi, Japan

¹⁰ Pacific Islands Fisheries Science Center, NOAA (retired), Honolulu, Hawaii, United States

12

Thank you George so much for supporting my & my student's participation in this phenomenal project. You are a very special person in my life and I hope you know how much you are appreciated! @ Laura

Trovan PIT Tug ID (Right shoulder)

1/20/2024

NO CITES

- 392145000819589
- 392145000962159
- 392145000955523
- 392145000819757
- 392145000960157
- 392145000958632
- 392145000959554
- 392145000817228
- 392145000817516
- 392145000958704
- 392145000959693
- 392145000958398
- 392145000816233
- 392145000819834
- 392145000817776
- 392145000820911
- 392145000956246
- 392145000816953
- 392145000836915
- 392145000817930
- 392145000821150
- 392145000960069
- 392145000820643
- 392145000960235
- 392145000820573
- 392145000958247
- 392145000817149
- 392145000957803
- 392145000818307
- 392145000961300

Sir George!
Thank you for teaching me so much and keeping me entertained with all the stories!!
I'll see you again on the big island!
-Charlotte

George,
It was so great to meet and get to know you on this trip! Your humor always made me smile! Hope to see you again!
-Jack

11/18/2022 - Attachment Design
Wildlife Cam - Spot 6-387 version

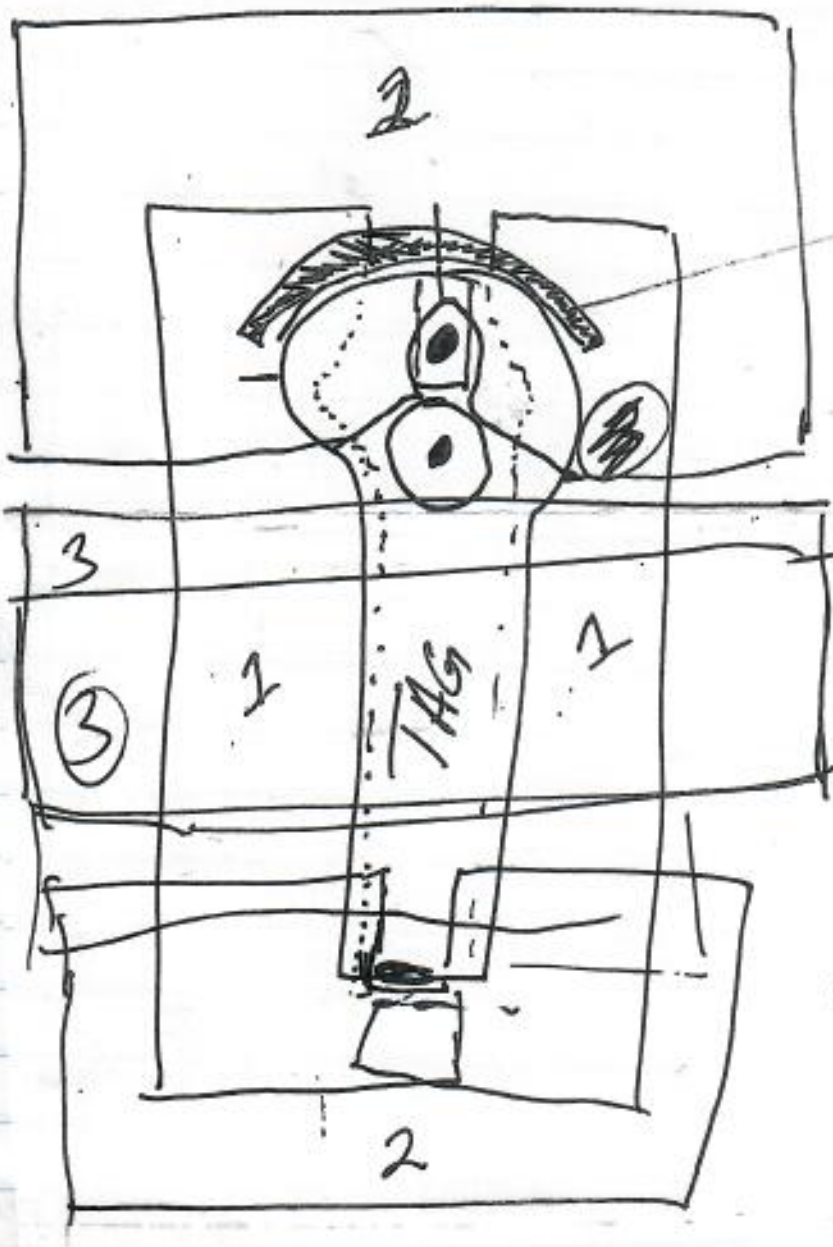

BY MARC RICE
Carbon Fiber bumper.

Make Side
→
Pieces (#1)
wider

3 LAYERS
TOTAL

Languages	name	meaning
Hawaiian	HO'OKELE	navigator
	MOANA KAI	deep open seas
	HOKU PA'A	fixed North star
	HO'O MAU	persistent, keep on going
	KAHIKINA	to the East
Japaneses	MITSUKI	<p>The old Japanese readings for January through December are applied from the top to the bottom. In that case, for May, the word would be "SATSUKI," but this word is used for flowers and has been used in 1st cohort. Therefore, MOL have changed it from MAY to MEI.</p>
	KISARAGI	
	YAYOI	
	UZUKI	
	MEI	
	MINA	
	FUMI	
	HAZUKI	
	NAGA	
	KANNNA	
	SHIMO	
	SHIWASU	
	YOROZU	

And just to clarify - the 4 island names are not actually the Chumash (indigenous) names - but rather are the current names (minus their prefixes) of the islands that make up the land of the "Island Chumash" tribe, to the best of my understanding.

Look forward to hearing more about the Cohort 2 turtles in the near future!

All the best,
Cali

California

On Wed, May 22, 2024 at 11:44 AM Larry B. Crowder <lbcrowd@stanford.edu> wrote:

Mori-San

The 5 english names are

N=5

- \ 'Ehnaally
- \ Miguel
- \ Rosa
- \ Cruz
- \ Anacapa

These are indigenous names for the Channel Islands in the Southern California Bight

The first name is an indigenous word for turtle

These are courtesy of Cali, Jeff S and me. Larry

the Baja California peninsula. To my surprise, it turned out more difficult than expected but here is the list we propose for this year's cohort:

Pericú: name of the ancestral inhabitants of the southern part of the peninsula and the following names come from their language (pericú) as described by one of our most famous scholars of native tongues in Mexico: Miguel León-Portilla

uriuri: to walk

eni: water

Niparaya: Lord who lives in the skies and made the Earth, the Sea and Food

Purutauí: the one who made the stars

best

Alberto

TOTAL N = 28
NAMES FOR 2024

On Wed, 22 May 2024 at 12:13, 'Cali Turner - NOAA Federal' via Loggerhead STRETCH <headstretch@noaa.gov> wrote:

Thank you for sharing these, Larry!

And just to clarify - the 4 island names are not actually the Chumash (indigenous) names - but rather are the current names (minus their prefixes) of the islands that make up the land of the "Island Chumash" tribe, to the best of my understanding.

Look forward to hearing more about the Cohort 2 turtles in the near future!

All the best,

Cali

On Wed, May 22, 2024 at 11:44 AM Larry B. Crowder <lbcrowd@stanford.edu> wrote:
Mori-San

The 5 english names are

'Ehnaally

Miguel

Rosa

Cruz

Anacapa

These are indigenous names for the Channel Islands in the Southern California Bight
The first name is an indigenous word for turtle

6/20/24

Sabine Winterowd: She lives in Japan with her parents. I believe that her father is an American teacher and her mother is a physician. She will not be staying at the hotel with us rather will be commuting from her home but will be with us on all research days. She is new to turtles but a lovely student and enjoys marine science.

Jack van der Reis: He lives in Oahu and just graduated from HPA. He is certified in our turtle program but was unable to participate in any trips due to his various school commitments. He will be attending Harvey-Mudd in the fall and very excited to be joining us. He will be on all the flights with us.

Charlotte Kassis: Charlotte has done everything with us related to turtles. She has traveled to Vanuatu, participated in almost all of our tagging trips since 7th grade (she is now a senior). She is currently working on an independent project chewing up some of the Vanuatu data with our recently tagged cohort. She will be in Japan already due to her father having an astronomy conference and is currently scheduled to join us Monday to Wednesday. She is from Waimea.

I think this will be an enjoyable group of students and believe that they will support

STRETCH
SEA TURTLE RESEARCH EXPERIMENT
THERMAL CORRIDOR HYPOTHESIS

GEORGE H. BALAZS
992 AWA'AWA'ANO'A PLACE
HONOLULU, HAWAII 96813

Egg
for 20 day
delays
etc. from
Goes from
12 noon
480 hours

START 6/17/2024

AREOS
ID

26

Serial #: 24U2386

PTT ID: 265570



HO'OKELE



高知大学
Kinki University



ALL 25
Programmed to
Transmit
Every other
Day

ON July 8 = 21 Day DELAY
2024

PNPA 2024

26

SEA TURTLE TAGGING FORM

DATE FORM FILLED OUT

STRETCH

N=7

CAPTURE DATE, LOCATION AND METHOD:

6-17-2024 Monday DAY 1

PERSON RECORDING DATA:

INCORPORATE
FLIPPER
TAG
ALL ON LEFT
FRONT FLIPPER

TAGS: 5326 LFL

TAGS: ALL SPOT 6 387

1/20/2024

392145000819589

STRAIGHT CARAPACE - LENGTH:

39.7 cm

PTROVAN
FIT
TAG

CURVED CARAPACE LENGTH:

HEAD WIDTH:

cm

GEORGE H. BALAZS
992 AWAAWAANOA PLACE,
HONOLULU, HAWAII 96825

ALL
IN RIGHT
SHOULDER

Sex: Male, Female or Undetermined

TAIL LENGTH: T

cm

cm

RIGHT FRONT FLIPPER WIDTH:

cm

PLASTRON LENGTH:

cm

WEIGHT:

#

SAMPLES COLLECTED:

STRETCH
SEA TURTLE RESEARCH EXPERIMENT
THERMAL CORRIDOR HYPOTHESIS

DESCRIPTIVE REMARKS:

STRETCH
SEA TURTLE RESEARCH EXPERIMENT
THERMAL CORRIDOR HYPOTHESIS



GEORGE H. BALAZS
992 AWAAWAANOA PLACE
HONOLULU, HAWAII 96822

STRETCH
SEA TURTLE RESEARCH EXPERIMENT
THERMAL CORRIDOR HYPOTHESIS

"HOKU PA'A"

27

Serial #: 24U2364



PTT ID: 265557

ARGOS
ID



387

21 Day Delay PNP 2024
SEA TURTLE TAGGING FORM
STRETCH

27

DATE FORM FILLED OUT

CAPTURE DATE, LOCATION AND METHOD:

6/17/24 Monday
PERSON RECORDING DATA:

TROVAN PIT
RIGHT SHOULDER

TAGS:
5327 LFL
INCONEL

TAGS:
GEORGE H. BALAZS
992 AWAAWAANOA PLACE
HONOLULU, HAWAII 96825

392145000962159

MT# 27

STRAIGHT CARAPACE - LENGTH:

cm

WIDTH:

cm

39.3 cm

CURVED CARAPACE LENGTH:

cm

WIDTH:

cm

HEAD WIDTH:

cm

STRETCH
SEA TURTLE RESEARCH EXPERIMENT
THERMAL CORRIDOR HYPOTHESIS

SEX: Male, Female
or Undetermined

TAIL LENGTH: T

cm

C

cm

SAMPLES COLLECTED:

RIGHT FRONT FLIPPER WIDTH:

cm

PLASTRON LENGTH:

cm

WEIGHT:

g

DESCRIPTIVE REMARKS:

"UAIN O'OH"

STRETCH
SEA TURTLE RESEARCH EXPERIMENT
THERMAL CORRIDOR HYPOTHESIS



GEORGE H. BALAZS
992 AWAAWAANOA PLACE
HONOLULU, HAWAII 96825

STRETCH
SEA TURTLE RESEARCH EXPERIMENT
THERMAL CORRIDOR HYPOTHESIS

ARGOS ID

"HO'O MAU"



28

Serial #: 24U2370

PTT ID: 265559



28

21 DAY Delay

PNPA 2024

SEA TURTLE TAGGING FORM

STRETCH

CAPTURE DATE, LOCATION AND METHOD:

6/17/24 Monday

PERSON RECORDING DATA:

TROVAN
PIT
RIGHT
SHOULDER

TAGS: 5328 LFA
INCORREL

TAGS:

392145000955523

STRETCH
SEA TURTLE RESEARCH EXPERIMENT
THERMAL CORRIDOR HYPOTHESIS

MT# 28

STRAIGHT CARAPACE - LENGTH:

cm

WIDTH: cm

37.2 cm

CURVED CARAPACE LENGTH:

cm

WIDTH: cm

HEAD WIDTH: cm

GEORGE H. BALAZS
992 AWAAWAANO A PLACE
HONOLULU, HAWAII 96825

SEX: Male, Female or Undetermined

TAIL LENGTH: T cm

C cm

RIGHT FRONT FLIPPER WIDTH: cm

SAMPLES COLLECTED:

PLASTRON LENGTH: cm

WEIGHT: #

DESCRIPTIVE REMARKS:



SEA TURTLE RESEARCH EXPERIMENT
THERMAL CORRIDOR HYPOTHESIS

STRETCH
SEA TURTLE RESEARCH EXPERIMENT
THERMAL CORRIDOR HYPOTHESIS

GEORGE H. BALAZS
992 AWAAWAANOA PLACE
HONOLULU, HAWAII 96825

"KAHIKINA"

~~29~~ 29

Serial #: 24U2376



PTT ID: 265562



ARGOS
ID

2 DAY delay

PNPA 2024

29

SEA TURTLE TAGGING FORM

DATE FORM FILLED OUT

STRETCH

CAPTURE DATE, LOCATION AND METHOD:

6/17/24 Monday
PERSON RECORDING DATA

TROVAN
FIT
RIGHT SHOULDER

TAGS:

5329LEL
INCONE4

TAGS:

392145000819757

STRETCH
SEA TURTLE RESEARCH EXPERIMENT
THERMAL CORRIDOR HYPOTHESIS

MT# 29

STRAIGHT CARAPACE LENGTH:

WIDTH:

40.1 cm

CURVED CARAPACE LENGTH:

WIDTH:

HEAD WIDTH:

GEORGE H. BALAZS
992 AWAAWAANOA PLACE
HONOLULU, HAWAII 96825

SEX: Male, Female
or Undetermined

TAIL LENGTH: T

C

SAMPLES COLLECTED:

RIGHT FRONT FLIPPER WIDTH:

PLASTRON LENGTH:

WEIGHT:

DESCRIPTIVE REMARKS:

STRETCH
SEA TURTLE RESEARCH EXPERIMENT
THERMAL CORRIDOR HYPOTHESIS



STRETCH
SEA TURTLE RESEARCH EXPERIMENT
THERMAL CORRIDOR HYPOTHESIS

GEORGE H. BALAZS
992 AWAAWAANOA PLACE
HONOLULU, HAWAII 96825

"MUTSUKI"

ARGOS ID

#30

Serial #: 24U2398

PTT ID: 265577



21 DAYS

DATE FORM FILLED OUT

PNPA 2024
SEA TURTLE TAGGING FORM
STRETCH

30

CAPTURE DATE/LOCATION AND METHOD:

6/17/2024 Monday

PERSON RECORDING DATA:

TROVAN
PIT RIGHT
SHOULDER

TAGS: 5330LFL
INCORREL

TAGS:

392145000960157

MT# 30

STRAIGHT CARAPACE - LENGTH:

cm

WIDTH:

cm

38.3 cm

CURVED CARAPACE LENGTH:

cm

WIDTH:

cm

HEAD WIDTH:

cm

GEORGE H. BALAZS
992 AWAAWAANOA PLACE
HONOLULU, HAWAII 96823

SEX: Male, Female
or Undetermined

TAIL LENGTH: T

cm

C

cm

SAMPLES COLLECTED:

RIGHT FRONT FLIPPER WIDTH:

cm

PLASTRON LENGTH:

cm

STRETCH
SEA TURTLE RESEARCH EXPERIMENT
THERMAL CORRIDOR HYPOTHESIS

WEIGHT:

#

DESCRIPTIVE REMARKS:

(mirrored text)



STRETCH
SEA TURTLE RESEARCH EXPERIMENT
THERMAL CORRIDOR HYPOTHESIS

STRETCH
SEA TURTLE RESEARCH EXPERIMENT
THERMAL CORRIDOR HYPOTHESIS

GEORGE H. BALAZS
992 AWA'AWA'ANO'A PLACE
HONOLULU, HAWAII 96825

shot in mobile

31

Serial #: 24U2377

PTT ID: 265563



ID ARG

"KISARAGI" (XRAYED) 4/2024



21 DAYS

PNPA 2024

SEA TURTLE TAGGING FORM

36

DATE FORM FILLED OUT

STRETCH

CAPTURE DATE, LOCATION AND METHOD:

6/17/2024 Monday

PERSON RECORDING DATA:

TROVAN. PIT
RIGHT SHOULDER

TAGS:

5332 LFL
INCONEL

TAGS:

391245000958632

MT#

31

STRAIGHT CARAPACE - LENGTH:

cm

WIDTH:

cm

36.0 cm

CURVED CARAPACE LENGTH:

cm

WIDTH:

cm

HEAD WIDTH:

cm

STRETCH
SEA TURTLE RESEARCH EXPERIMENT
THERMAL CORRIDOR HYPOTHESIS

SEX: Male, Female
or Undetermined

TAIL LENGTH: T

cm

C

cm

SAMPLES COLLECTED:

RIGHT FRONT FLIPPER WIDTH:

cm

PLASTRON LENGTH:

cm

WEIGHT:

#

DESCRIPTIVE REMARKS:

GEORGE H. BALAZS
992 AWAAWAANO A PLACE
HONOLULU, HAWAII 96825

Handwritten notes and markings at the bottom of the page, including "TROVAN" and "32".

STRETCH
SEA TURTLE RESEARCH EXPERIMENT
THERMAL CORRIDOR HYPOTHESIS



STRETCH
SEA TURTLE RESEARCH EXPERIMENT
THERMAL CORRIDOR HYPOTHESIS

GEORGE H. BALAZS
892 AWAAWAANOA PLACE
HONOLULU, HAWAII 96821

"YAYOI"



32

Serial #: 24U2397

PTT ID: 265584



ARGENT
I D

21 DAYS DELAY
DATE FORM FILLED OUT

PNPA 2024
SEA TURTLE TAGGING FORM

U=END
DAY 1

STRETCH (32)

CAPTURE DATE, LOCATION AND METHOD:

6-17-2024 Monday

PERSON RECORDING DATA:

TROVAN PIT
RIGHT SHOULDER

TAG: 5278
INCONEL

TAGS:

392145000817516

STRETCH
SEA TURTLE RESEARCH EXPERIMENT
THERMAL CORRIDOR HYPOTHESIS

MT# 32

STRAIGHT CARAPACE - LENGTH:

cm

WIDTH:

cm

35.2
cm

CURVED CARAPACE LENGTH:

cm

WIDTH:

cm

HEAD WIDTH:

cm

GEORGE H. BALAZS
992 AWAAWAANOA PLACE
HONOLULU, HAWAII 96823

SEX: Male, Female
or Undetermined

TAIL LENGTH: T

cm

C

cm

SAMPLES COLLECTED:

RIGHT FRONT FLIPPER WIDTH:

cm

PLASTRON LENGTH:

cm

WEIGHT:

#

DESCRIPTIVE REMARKS:

SEA TURTLE RESEARCH EXPERIMENT
THERMAL CORRIDOR HYPOTHESIS



STRETCH
SEA TURTLE RESEARCH EXPERIMENT
THERMAL CORRIDOR HYPOTHESIS

GEORGE H. BALAZS
992 AWAAWAANOA PLACE
HONOLULU, HAWAII 96825

"UZUKI"

ARGOS ID

ARGOS ID

265564

4/20/24
(X-RAY)

#33

3390
高知大学
Kochi University



Serial #: 24U2378

PTT ID: 265564



33

20 Days Delay

PNPA 2024
SEA TURTLE TAGGING FORM

START DAY 2

DATE FORM FILLED OUT

STRETCH

CAPTURE DATE, LOCATION AND METHOD:

6-18-2024 TUESDAY

PERSON RECORDING DATA:

TAGS:

5278
INCOSEL

TAGS:

STRETCH
SEA TURTLE RESEARCH EXPERIMENT
THERMAL CORRIDOR HYPOTHESIS

TROVAN PIT
Right SHOULDER

392145000958704

MT# 33

STRAIGHT CARAPACE - LENGTH:

38.1 cm

WIDTH: cm

cm

cm

cm

CURVED CARAPACE LENGTH:

cm

WIDTH: cm

HEAD WIDTH: cm

GEORGE H. BALAZS
992 AWAAWAANOA PLACE
HONOLULU, HAWAII 96825

SEX Male, Female or Undetermined

TAIL LENGTH: T cm

C cm

RIGHT FRONT FLIPPER WIDTH:

cm

SAMPLES COLLECTED:

PLASTRON LENGTH: cm

WEIGHT: #

DESCRIPTIVE REMARKS:

392145000958704



SEA TURTLE RESEARCH AND RECOVERY
PROGRAM
1000 BAKER DRIVE
HONOLULU, HAWAII 96813

STRETCH
SEA TURTLE RESEARCH EXPERIMENT
THERMAL CORRIDOR HYPOTHESIS

GEORGE H. BALAZS
992 AWAAWAANO A PLACE
HONOLULU, HAWAII 96825

34
Barcode
24U2380

34

"MEI"

Serial #: 24U2380



PTT ID: 265566

265566

ARGOS
ID

34  

高知大学
Kochi University

34

20 DAYS DELAY

PNPA 2024

SEA TURTLE TAGGING FORM

STRETCH

DATE FORM FILLED OUT

CAPTURE DATE, LOCATION AND METHOD:

6/18/24 TUESDAY

PERSON RECORDING DATA:

TROVAN PIT
RIGHT SHOULDER

TAGS:

5282 LFL
INCONEL

TAGS:

STRETCH
SEA TURTLE RESEARCH EXPERIMENT
THERMAL CORRIDOR HYPOTHESIS

392145000959693

MT# 34

STRAIGHT CARAPACE - LENGTH:

38.6 cm

WIDTH: cm

cm

cm

cm

CURVED CARAPACE LENGTH:

cm

WIDTH: cm

HEAD WIDTH: cm

GEORGE H. BALAZS
992 AWAAWAANOA PLACE
HONOLULU, HAWAII 96825

SEX: Male, Female, or Undetermined

TAIL LENGTH: T cm

C cm

SAMPLES COLLECTED:

RIGHT FRONT FLIPPER WIDTH: cm

cm

PLASTRON LENGTH: cm

cm

WEIGHT: #

#

DESCRIPTIVE REMARKS:



SEA TURTLE RESEARCH EXPERIMENT
THERMAL CORRIDOR HYPOTHESIS

STRETCH
SEA TURTLE RESEARCH EXPERIMENT
THERMAL CORRIDOR HYPOTHESIS



GEORGE H. BALAZS
192 AWAAWAANO A PLACE
HONOLULU, HAWAII 96825

35
Serial # 24U2382
PTT ID: 26568

ARGON ID "MINA"
265568

35  高知大学
Kochi University

35

Serial #: 24U2382 
PTT ID: 265568 

35

20 DAYS DELAY

PNPA 2024
SEA TURTLE TAGGING FORM

DATE FORM FILLED OUT

STRETCH

CAPTURE DATE, LOCATION AND METHOD:

6	18	24	Tuesday
---	----	----	---------

PERSON RECORDING DATA:

TROVAN
PLT
RIGHT
SHOULDER

INCORREL

TAGS:

52834FL

TAGS:

392145000958398

STRETCH
SEA-TURTLE RESEARCH EXPERIMENT
THERMAL CORRIDOR HYPOTHESIS

MT#

35

STRAIGHT CARAPACE - LENGTH:

WIDTH:

38.1 cm

CURVED CARAPACE LENGTH:

WIDTH:

HEAD WIDTH:

GEORGE H. BALAZS
992 AWAAWAANOA PLACE
HONOLULU, HAWAII 96825

SEX: Male, Female
or Undetermined

TAIL LENGTH: T

C

RIGHT FRONT FLIPPER WIDTH:

SAMPLES COLLECTED:

PLASTRON LENGTH:

WEIGHT:

DESCRIPTIVE REMARKS:

7/7/24 Didn't feed on SHIP AFTER THIS DATE.
All Released 7/7/2024



SEA TURTLE RESEARCH EXPERIMENT
THERMAL CORRIDOR HYPOTHESIS

STRETCH
SEA TURTLE RESEARCH EXPERIMENT
THERMAL CORRIDOR HYPOTHESIS

GEORGE H. BALAZS
992 AWAAWAANOA PLACE
HONOLULU, HAWAII 96822

36
Serial #: 24U2392
PTT ID: 265575

ARGOS ID 265575 "FUMI" 4/2024 (X-RAYED) # 36

3690 高知大学 Koshi University



Serial #: 24U2392

PTT ID: 265575



36

70 DAYS DELAY

PNPA 2024
SEA TURTLE TAGGING FORM

DATE FORM FILLED OUT

STRETCH

CAPTURE DATE, LOCATION AND METHOD:

6/18/24 Tuesday

PERSON RECORDING DATA:

TROVAD PIT
RIGHT SHOULDER

TAGS:

INANEL 5284 FL

TAGS:

STRETCH
SEA TURTLE RESEARCH EXPERIMENT
THERMAL CORRIDOR HYPOTHESIS

392145000816233

MT#

36

STRAIGHT CARAPACE - LENGTH:

36.0 cm

WIDTH: cm

cm

cm

cm

CURVED CARAPACE LENGTH:

cm

WIDTH: cm

HEAD WIDTH: cm

cm

GEORGE H. BALAZS
992 AWAAWAANOA PLACE
HONOLULU, HAWAII 96825

SEX: Male, Female
or Undetermined

TAIL LENGTH: T cm

cm

C cm

cm

SAMPLES COLLECTED:

RIGHT FRONT FLIPPER WIDTH: cm

cm

PLASTRON LENGTH: cm

cm

WEIGHT: #

#

DESCRIPTIVE REMARKS:



STRETCH
SEA TURTLE RESEARCH EXPERIMENT
THERMAL CORRIDOR HYPOTHESIS

STRETCH
SEA TURTLE RESEARCH EXPERIMENT
THERMAL CORRIDOR HYPOTHESIS

GEORGE H. BALAZS
992 AWAAWAANOA PLACE
HONOLULU, HAWAII 96822

37
Serial #: 24U2399
PTT ID: 265578

#37

ARGOS
ID 265578
"HAZUKI"

Serial #: 24U2399



PTT ID: 265578

3790
高知大学
Kochi University



20 DAYS

31

PNPA 2024

SEA TURTLE TAGGING FORM

DATE FORM FILLED OUT

STRETCH

CAPTURE DATE, LOCATION AND METHOD:

6/18/24	Tuesday
PERSON RECORDING DATA:	

TROVAN PIT
RIGHT SHOULDER

TAGS: 5285FL

TAGS:

INCORP

392145000819834

STRETCH
SEA TURTLE RESEARCH EXPERIMENT
THERMAL CORRIDOR HYPOTHESIS

MT# 37

STRAIGHT CARAPACE - LENGTH:

41.3 cm

WIDTH: cm

CURVED CARAPACE LENGTH:

WIDTH: cm

HEAD WIDTH:

GEORGE H. BALAZS
992 AWAAWAANOA PLACE
HONOLULU, HAWAII 96825

SEX: Male, Female
or Undetermined

TAIL LENGTH: T

RIGHT FRONT FLIPPER WIDTH:

SAMPLES COLLECTED:

PLASTRON LENGTH:

WEIGHT:

DESCRIPTIVE REMARKS:



SEA TURTLE RESEARCH EXPERIMENT
THERMAL CORRIDOR HYPOTHESIS

STRETCH
SEA TURTLE RESEARCH EXPERIMENT
THERMAL CORRIDOR HYPOTHESIS

GEORGE H. BALAZS
992 AWA'AWA'ANO'A PLACE
HONOLULU, HAWAII 96825

38
Serial #: 24U2401
PTT ID: 265579

ARGOS
ID 265579
"NAGA"

38  高知大学
Kochi University

~~#~~ 38
Serial #: 24U2401

PTT ID: 265579



20 DAYS Delay

38

PNPA 2024

SEA TURTLE TAGGING FORM

DATE FORM FILLED OUT

STRETCH

CAPTURE DATE, LOCATION AND METHOD:

6/18/24
PERSON RECORDING DATA:

TROVAN PIT Right Shoulder

TAGS:

INCONEL

5286 FL

TAGS:

392145000817776

STRETCH
SEA TURTLE RESEARCH EXPERIMENT
THERMAL CORRIDOR HYPOTHESIS

MT#

38

STRAIGHT CARAPACE - LENGTH:

WIDTH:

38.4 cm

CURVED CARAPACE LENGTH:

WIDTH:

HEAD WIDTH:

GEORGE H. BALAZS
992 AWA'AWAANO'A PLACE
HONOLULU, HAWAII 96823

SEX: Male, Female
or Undetermined

TAIL LENGTH: T

C

SAMPLES COLLECTED:

RIGHT FRONT FLIPPER WIDTH:

PLASTRON LENGTH:

WEIGHT:

DESCRIPTIVE REMARKS:

> 7/3/24 Didn't Feed on ship
After this DATE.
All Turtles Released 7/7 2024



STRETCH
SEA TURTLE RESEARCH EXPERIMENT
THERMAL CORRIDOR HYPOTHESIS

STRETCH
SEA TURTLE RESEARCH EXPERIMENT
THERMAL CORRIDOR HYPOTHESIS

GEORGE H. BALAZS
992 AWAAWAANOA PLACE
HONOLULU, HAWAII 96921

39
Serial #: 24U2402
PTT ID: 265585

ARGOS ID "KANNA"
265585

~~39~~ 39

Serial #: 24U2402



PTT ID: 265585



20 DAYS
Delay

39

PNPA 2024

SEA TURTLE TAGGING FORM

DATE FORM FILLED OUT

STRETCH

CAPTURE DATE, LOCATION AND METHOD:

6/18/24 TUESDAY	
PERSON RECORDING DATA:	

TROVAN
PIT
RIGHT SHOULDER

TAGS: 5287LEL

INCONEL

392145000820911

STRETCH
SEA TURTLE RESEARCH EXPERIMENT
THERMAL CORRIDOR HYPOTHESIS

MT#

39

STRAIGHT CARAPACE - LENGTH:

WIDTH:

39.2 cm

CURVED CARAPACE LENGTH:

WIDTH:

HEAD WIDTH:

GEORGE H. BALAZS
992 AWAAWAANOA PLACE
HONOLULU, HAWAII 96825

SEX: Male, Female
or Undetermined

TAIL LENGTH: T

C

SAMPLES COLLECTED:

RIGHT FRONT FLIPPER WIDTH:

PLASTRON LENGTH:

WEIGHT:

DESCRIPTIVE REMARKS:

20 DAYS
DEAD

39

PNPA 2024

SEA TURTLE TAGGING FORM

STRETCH

DATE FORM FILLED OUT

CAPTURE DATE, LOCATION AND METHOD:

6/18/24 TUESDAY

PERSON RECORDING DATA:

FROM VAN PIT RIGHT SHOULDER

TAGS: 5287 LFL

INCONEL

TAGS:

392145000820911

STRETCH
SEA TURTLE RESEARCH EXPERIMENT
THERMAL CORRIDOR HYPOTHESIS

MT#

39

STRAIGHT CARAPACE - LENGTH:

WIDTH:

39.2 cm

CURVED CARAPACE LENGTH:

WIDTH:

HEAD WIDTH:

GEORGE H. BALAZS
992 AWAAWAANOA PLACE
HONOLULU, HAWAII 96825

SEX: Male, Female
or Undetermined

TAIL LENGTH: T

C

RIGHT FRONT FLAPPER WIDTH:

SAMPLES COLLECTED:

PLASTRON LENGTH:

WEIGHT:

DESCRIPTIVE REMARKS: